



CleanTech[®] 2000S

INSTALLATION AND OPERATION MANUAL



March 31, 2020

CLEANTECH® 2000S

Station

Automated Hand & Glove Cleansing System

INSTALLATION AND OPERATION MANUAL

Manufactured by:

Meritech Systems, LLC
720 Corporate Circle, Suite K
Golden, CO 80401 USA

Phone: (800) 932-7707

Fax: (303) 790-4859

www.meritech.com

E-mail: cleantechinfo@meritech.com

E-mail: service@meritech.com



WARNING: The performance and effectiveness of CleanTech® systems have been extensively tested when using solutions provided by Meritech Systems, LLC. Satisfactory performance or effectiveness cannot be guaranteed when other solutions are used.

FAILURE TO USE MERITECH SYSTEMS LLC, SUPPLIED CHEMICALS WILL VOID ANY AND ALL WARRANTIES.

March 31, 2020

MERITECH SYSTEMS, LLC CleanTech®
Installation and Operation Manual

Table of Contents	3
Introduction	4
Achieving the Optimum Wash	5
Who to Call if You Need Help	6
2000S Detail	7-8
The Hand Cleansing Cycle	9-10
Helpful Pointers For Trouble Free Operation	11
Front Panel Indicators	12-14
Detailed System Reference	15
Water and Temperature Controls	
Cylinder Rotation	
Solution Delivery	16
Changing Solution Containers	17-18
Removing an Empty Container	
Installing a New Container – Hygiene Solution	
Installing a New Container - Selfclean	
Solutions Replacement Diagram	19-20
Maintenance / Adjustments	21-22
Unpacking Instructions	23
Installation Guide	24
Facility Utility Locations	25
Cut Sheet	26-27
Optional Boot Sanitizing Pan	28
Optional Air Curtain	29
System Specifications	30-31
If External Backflow Prevention is needed	32
Contacting Meritech	33
Meritech Systems, LLC Warranty	34
Terms & Conditions of Sale	35

Introduction

Thank you for selecting the CleanTech® 2000S Automated Handwashing Station as a component in your hand washing regimen. We designed the Series 2000S to provide your facility with an automated, turnkey systems, that meets or exceeds your hand cleansing requirements for compliance, standardization and effectiveness.

This manual describes everything you will need to properly site, install and maintain your system. The CleanTech® 2000S will fit into an area that accommodates a 19" x 18.8 footprint or 42" x 18.8" in installed with the optional footwear sanitizing options and will hook-up to your existing, standard hot and cold-water lines and drain. A more detailed description of the installation procedure can be found in the Installation Guide of this manual.

Select an area for installation that is level and encourages frequent use in your facility. We recommend positioning the Series 2000S near the main work area, lunch facilities, restroom facilities, and close to the entrance and exit doors.



Achieving the Optimum Wash

The CleanTech® 2000S Station provides a no-touch, completely automatic hand wash by sequentially delivering handwashing solution and water in a stimulating spray to the hands or gloves from finger tips to wrist. The system can wash up to 5 people per minute. The system uses the Ultrapure hygiene solution and water to remove 99.9% and greater pathogens from the hands or gloves. The system can also remove particles, sodium's and other contaminants. The standard system configuration is 12 seconds which consists of a wash cycle using hand washing solution that clean and sanitize and a potable water rinse cycle. A helical configuration of jet nozzles located within the two rotating cylinders is used to spray the mixture of solutions and pressurized water onto the hands followed by a potable water rinse.

To minimize cross-contamination, an infrared photo optical sensor positioned directly above the cylinders automatically senses the presence of your hands when they enter the cylinders. To trigger a wash cycle, it will not be necessary to touch any part of the system; simply insert your hands into the cylinders.

One complete hand wash cycle will automatically dispense the appropriate volume of hygiene solution followed by a potable water rinse. The minimum time interval between user cycles is approximately 2 seconds.

The Selfclean cycle initiates automatically on a factory preset schedule and dispenses a sufficient amount of hard surface cleaner to eliminate microorganisms from the hand wash cylinders through to the facility drain. The Selfclean cycle will initiate once per day. For boot sanitizing option see separate manual for function and installation. A low moisture footwear sanitizing option is also available for sanitizing footwear in areas that must stay dry. See separate manual for functions and installation.

The optional air curtain can be installed on the system to automatically turn on at the end of the cycle and blow compressed air on to the hands as long as the photoeye is blocked. This can be used to just knock off most of the water drops in just about 3 seconds or used to completely dry the hands in approximately 35 seconds.

The optional stainless-steel plumbing cover shroud is available to cover water lines, drain line, & electrical cords. See separate manual for function and installation.

Who to call if you need help

The CleanTech® 2000S connects easily to your existing hot and cold-water lines using standard 3/4 inch "garden hose" style fittings. These fittings were chosen because they are commonly available, very reliable and can be disconnected quickly. You will also need a grounded 120 VAC electrical outlet, and a standard 1 1/2" schedule 40 PVC drain line.

If these hook-ups are not readily available, you will need to consult with your commercial plumber or electrician. Because of the different building codes and licensing regulations, Meritech cannot accept responsibility for providing plumbing and electrical modifications to your facility. However, a Meritech representative will be happy to provide the necessary guidance to ensure a correct installation. Follow the instructions in the installation guide of this manual for further installation information.

Consult local and national codes: conformity and compliance to local and national codes is the responsibility of the installer.

**IF YOU SHOULD EXPERIENCE ANY DIFFICULTY OR ARE UNSURE ABOUT THE
INSTALLATION PROCEDURE, WE ENCOURAGE YOU TO CONSULT IMMEDIATELY WITH
MERITECH SYSTEMS LLC.**



Manufactured by:

Meritech Systems, LLC
720 Corporate Circle, Suite K
Golden, CO 80401 USA

Phone: (800) 932-7707

Fax: (303) 790-4859

www.meritech.com

E-mail: cleantechinfo@meritech.com

E-mail: service@meritech.com

2000S Detail

Layout, Front View

CleanTech® 2000S HANDWASHING STATON



Solutions Housing



Layout – Back View

CleanTech® 2000S HANDWASHING STATION (back view of system)

- Cold Water Inlet (3/4" male garden hose fitting)
- B. System Drain (1.5" pipe stub, pipe stub sticks out of system 3")
- C. Hot Water Inlet (3/4" male garden hose fitting)
- D. System Power Cord
- E. Adjustable Leveling Foot (6 places, all vertical dimension can increase by 2")
- F. Optional Air Curtain Inlet (1/2" FNPT fitting)

System Power Cord



The Hand Cleansing Cycle

Check all water hook-ups to ensure they are open and not leaking. Plug the power cord into an electrical outlet and verify power on (the display panel, master count, & resettable counter will be illuminated). The system will start a Selfclean cycle that will take approximately 20 seconds cleaning the systems. Do not put your hands in the cylinders during the Selfclean cycle as the system will stop and not restart till the photo electric eye is unblocked. The system is ready for hand washing.

Solution will be drawn from the 2 ½ gallon container. As solution is consumed the light bar will indicate the level of solution in the bottle and will flash when the contain is empty. The display will also tell you when the solution is empty. The Selfclean solution will be drawn from the 1-gallon container installed in the right of each bay of the system.

FOLLOWING THIS PROCEDURE WILL ENSURE THE MOST EFFECTIVE WASH IN THE SHORTEST PERIOD OF TIME

1. To initiate a cycle, stand directly in front of the system and place your hands simultaneously into the center of each cylinder.
2. The hygiene cycle will automatically start as your hands enter the cylinders. Position your hands at a depth so the outer most ring of the water spray covers the wrist.
3. The countdown timer will begin to countdown from 12 – 0 and the display will show “WASHING”.
4. You will receive the most effective wash with the hygiene solution is you relax, center your hands within the cylinder with your fingers slightly spread.
5. At 6 seconds the system will switch from “WASHING” to “RINSING”. They cycle is complete once the countdown is at zero and the water shuts off.

During the Selfclean function the system countdown time will count down from 14 (on initial power up or 20 seconds (during normal operation) and the display will display “SELF CLEAN KEEP HANDS OUT”. This function on happens once per day. The Selfclean cycle only takes 20 seconds.

The Hand Cleansing Cycle - Continued



NOTE: The infrared photo optical sensor will not reset until the hands are removed.

Helpful Pointers for Trouble Free Operation

Avoid touching or resting your hands and forearms on the cylinders themselves. If you apply pressure to the cylinder walls, the cylinders have been designed to stop spinning and will restart once you have stopped impeding their rotation.

Occasionally you may encounter a condition where you have placed your hands into the cylinders, but nothing happens. This condition generally occurs when the next cycle is requested before the previous wash cycle is completed. To reset the cycle, simply remove your hands, wait for 3 seconds and reinsert your hands into the cylinders.

During periods of infrequent use, the water temperature may cool. This will have no effect on the quality of the hygiene event and the wash you will receive, the cleansing solution works properly through a broad range of temperatures. The period of time for the warm water to return to the station will depend on the distance of the hot water source from the station. In extreme cases or in cold environments it may be beneficial to have a booster water heater near the system.

The Series 2000S has been designed to be left in the "power on" mode over normal periods of operation. During extended periods of time (a month or longer) when the system will not be used, we recommend removing the solution container, placing the pick-up tubes from the solution containers, into a container of hot water and running several hand wash cycles and cycling the power of the station by unplugging electrical cord from the wall outlet, wait 3 seconds, and plug back in. This will start a Selfclean cycle and draw water in these lines to flush. This will flush all the lines of solutions, which tend to thicken significantly with time and may clog the system. After flushing the lines, close the facility water shut-off valves and unplug the system.

Front Panel Indicators

The CleanTech 2000S station is equipped with a solutions indicator light bar, a Selfclean solutions indicator light bar to indicate the level of the solutions in each container. The station has a display that will indicate when solutions are empty and needs to be replaced, Master & Resettable Compliance Monitor, when washing and when rinsing. The station also has a countdown timer that counts down from 12 – 0 and when it hits 0 it is safe to remove the hands and the hygiene cycle is complete. The station will also give a notification that the system is running a Selfclean cycle and to **“KEEP HANDS OUT”**

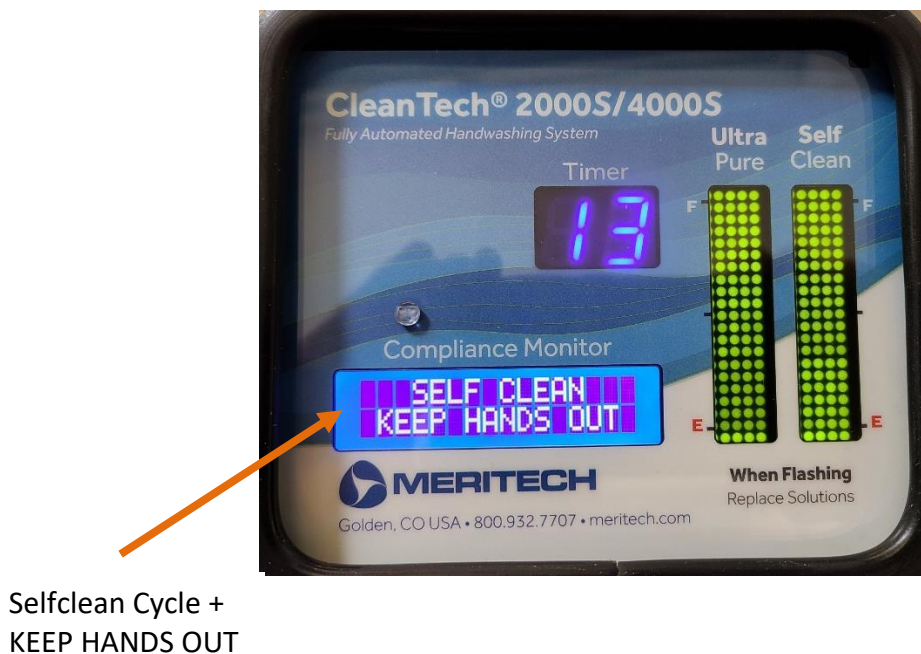

Front Panel Indicators - Continued



Front Panel Indicators - Continued

Station Washing



Station Rinsing



Detailed System Reference

Water and Temperature Controls

The CleanTech® 2000S blending valve is calibrated at the factory at a pre-set temperature (usually between 100° - 105° Fahrenheit). While the calibrated temperatures are usually accurate within +/- 2° F, temperature can be dependent upon the hot and cold-water inlet temperatures and pressures.

Hot water is not produced by the CleanTech® system. If facilities hot water is not 135°F or greater, the CleanTech® system may not be able to achieve the recommended water temperature for hand wash. In cold rooms where the hot water loses its heat through the hot water pipe and cold-water temperature is extremely low, it may be necessary to have a booster heater located near the CleanTech® system. **CleanTech® systems are not compatible with instantaneous or tankless water heaters.** For specific application assistance, contact Meritech at 1-800-932-7707.

Consult with local plumbing authorities for proper connections and installation requirements. The customer installed hot and cold-water control shut-off valves should be located near the system. These valves control the supply of water from the main water lines to the system. If you detect a water leak, close both the hot and cold water shut-off valves and unplug the system.

Leaks may occur at tubing connections or at pipe and hose fittings. You can save the expense of a costly repair call by tightening the connection yourself, if the leak persists contact either Meritech or your plumber.

To decrease water pressure, splash out, and flow; partially close the facility hot/cold water valves equally to achieve the desired pressure/flow.

Cylinder Rotation

The wash cylinders are made of durable plastic and can be stopped at any time by placing light pressure on the cylinder walls. This feature has been designed to ensure safe operation at all times.

Do not worry if large pieces of debris fall into the cylinders. The bottom of the cylinders will act as a trap. Simply reach in and remove the debris. Smaller pieces of debris will fall through the cylinder and out through the system drain.

Solution Delivery

During each wash cycle, approximately 5 – 7ml of hygiene solution is injected from its container and delivered to the hands through the jet nozzles located in the walls of the cylinders. The CleanTech® 2000S ensures the uniform delivery and dispersal of the hygiene solution with adequate water pressure to the system. At least 40-PSI dynamic (during water flow) inlet water pressure is required.

The system will continuously monitor the delivery of the solution and will automatically signal an improper delivery on the front panel monitor. Visually examine each container and its clear delivery lines to determine if there is adequate fluid present and that the line is not blocked. Change the solution containers if they are empty.

The hand wash cycle consists of a wash and potable water rinse. The wash portion of the cycle mixes hygiene solution with water followed by a potable water rinse. The cycle length is normally 12 seconds but can be programmed over a wide timing range. All system programming is done either at the factory or by an authorized Meritech technician. **DO NOT ATTEMPT TO PROGRAM OR REPROGRAM YOUR SYSTEM.**

When the hand wash solution container is empty, the light bar will flash empty and the display will display “ULTRAPURE SOL. EMPTY”.

Selfclean Cycle / Optional Boot Dip

To minimize the potential for microbial build-up in the system and facility water drain, the station automatically engages, on a programmable schedule of a Selfclean cycle. During this cycle water is turned on and a Selfclean solution is dispensed into the cylinders and all downstream lines, including the drain trap. The self- clean cycle is preset to activate once per day and takes approximately 20 seconds.

The Meritech CleanTech 2000S system with optional Boot Sanitizing Pan provides a means of washing hands and sanitizing footwear at the same time of your employees. At the completion of every handwash cycle, the system replenishes the boot sanitizing pan with additional Selfclean solution and water mixed at the correct ratio to keep the PPM at a high consistent level. The PPM of the solution is controlled between 800 – 1000 PPM of the Meritech Selfclean Solution. Please see separate manual for installation and maintaining the boot dip pan.

Once the Selfclean cycle is completed the station will completely rinse out the system. If hands are inserted during this cycle, the system will stop and wait for the hands to be removed before re-starting the cycle.

Changing Solution Container

Removing an Empty Container

- 1 To remove an empty container, simply loosen the cap on the 2 ½ gallon container and remove the tube assembly from the empty container. **DISPOSE OF CONTAINER ACCORDING TO LOCAL, STATE, AND FEDERAL REGULATIONS AND DO NOT REFILL USED CONTAINERS.**

Installing a New Container – 2 ½ Gallon

The solution containers can be installed quickly and easily. Follow these steps for all installations:

1. Unscrew the protective cap from the new 2 ½ gallon solutions container and discard.
2. Place the new container in the system.
3. Install the pickup tube assembly from the system into the new container and tighten cap.
4. After installing the new solutions container, run 5 handwashes to re-prime the solutions line.

Changing Selfclean Container

Installing a New Selfclean Container – 1 Gallon

The Selfclean solution container can be installed quickly and easily. Each case of solutions contains two solution tube assemblies (each assembly consists of a cap, red tube barb and tube). Follow these steps for all installations (including first time):

1. Unscrew the protective cap from the solutions container and discard. Insert the cap from the solutions tube assembly bag onto the solutions tube barb. Place this into the solutions container and loosely tighten the cap onto bottle.
2. Fit the tube from the CleanTech® 2000S to the horizontal connection of the tube assembly and place the container in the right position of each bay of the station on the lower shelf.
3. Double check to make sure that the Selfclean solution bottles are in the right position (when facing the unit). Labels in the solution housing indicate which container is to be installed in which position.
4. The Selfclean solution will be re-primed during the next Selfclean event that is every 24 hours or once per day.

FOR FURTHER ASSISTANCE CHANGING THE SOLUTIONS CONTAINERS, REFER TO THE SOLUTIONS REPLACEMENT DIAGRAM LOCATED ON PAGE 17 & 18 OF THIS MANUAL.

WARNING:

The Selfclean solution is located in the far-right container position (when facing the front of each bay of the system). Use care when removing, installing or handling the Selfclean solution. Be careful not to interchange the Selfclean solution with the hand cleaning solution.

Solutions Replacement Diagram – 2 ½ Gallon Container

SOLUTIONS REPLACEMENT INSTRUCTIONS

CAUTION: REPLACE SOLUTION CONTAINER WITH SAME TYPE OF SOLUTION

1

LOOSEN CAP & REMOVE TUBE ASSEMBLY FROM EMPTY CONTAINER & DISCARD EMPTY CONTAINER

2

REMOVE CAP FROM NEW SOLUTIONS CONTAINER & DISCARD

3

PLACE NEW CONTAINER IN SYSTEM & INSTALL TUBE ASSEMBLY FROM THE SYSTEM IN THE NEW CONTAINER, TIGHTEN CAP



**FOR CUSTOMER CARE: CALL (800)932-7707
SERVICE@MERITECH.COM**

Solutions Replacement Diagram – 1 Gallon Container

SOLUTIONS REPLACEMENT INSTRUCTIONS

CAUTION: REPLACE SOLUTION CONTAINER WITH SAME TYPE OF SOLUTION

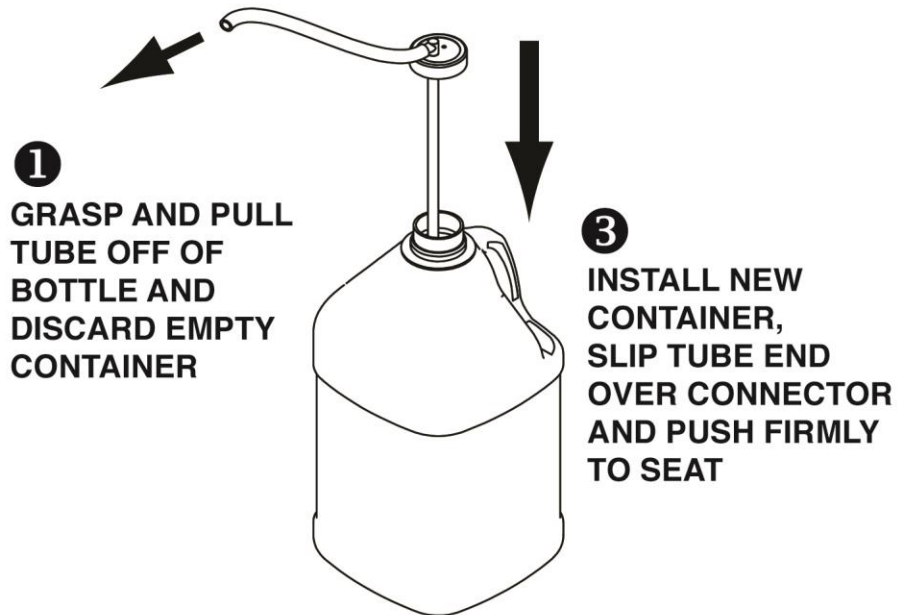

1
GRASP AND PULL
TUBE OFF OF
BOTTLE AND
DISCARD EMPTY
CONTAINER

3
INSTALL NEW
CONTAINER,
SLIP TUBE END
OVER CONNECTOR
AND PUSH FIRMLY
TO SEAT

2 INSTALL NEW TUBE ASSEMBLY
IN NEW SOLUTION CONTAINER
AND TIGHTEN BOTTLE CAP

FOR CUSTOMER SERVICE
CALL (800) 932-7707

Maintenance

Weekly:

- Pour, rub or spray bleach, ammonium chloride, hydrogen peroxide or other hard surface disinfectant into each cylinder to kill any bacteria that may be in the system or facility drain.
- Clean front surfaces and cylinders with a cleaning agent that removes mineral deposits.

Quarterly:

- Clean photo optical sensor lenses with water and a clean soft cloth.
- Remove all solutions bottles. Fill a container with hot water; put all pick up tubes in the hot water. Run 20-30 hand wash cycles to flush the hot water through the soap lines. Let soak for 5 minutes. Reinstall tubes and solutions bottles. Plug system back in and run system through (10) hand wash cycles.

Biannually:

- Unplug system and close facility water shut off valves. Remove hose fittings from hot and cold-water inlets. Remove water filter screens, rinse clean with tap water and reinstall water filter screens and hot and cold inlet lines. Turn facility water shut off valves on, plug system in and check for leaks.
- The system should be serviced by a Meritech technician to perform biannual maintenance.

Taring System:

- On occasion it may be necessary to re-tare the solutions scale in the system.
 - To re-tare the solution of Selfclean scale, remove the solutions containers from the system and verify nothing is on the weigh plate.
 - Press the tare button and system will go into re-taring mode and display will indicate taring. This takes only 2 seconds to re-tare the station.

Once complete, re-install the solutions container and verify the solutions light bar is reading correctly. See next page for a picture of these steps

As Needed:

- Replace cylinders every 30,000 – 50,000 hand wash cycles or when mineral deposits buildup or water splash out becomes excessive. This should be done by a Meritech technician.

ADJUSTMENTS:

Adjustments should be made by a Meritech technician. (See page 20 for contact information)

Please request a full Automated handwashing procedure that can be used within your HACCP or SSOP procedures.

Maintenance - Continued

Taring:

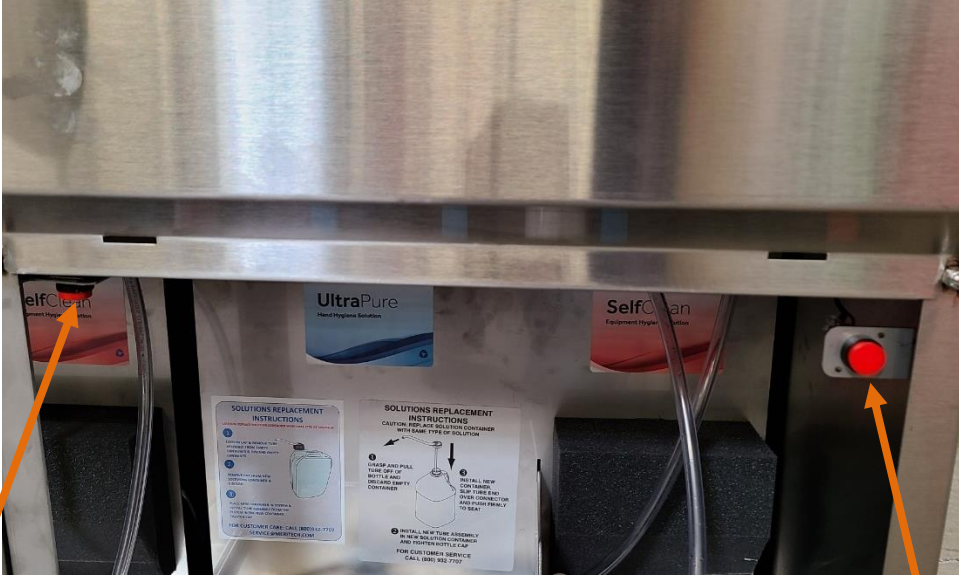

Tare Button

Optional Boot Dip Prime Button

Unpacking Instruction

Preparing system for Unpacking/Installation

Carefully Remove Tape



Carefully Remove Tape

Carefully Remove Tape



Carefully Remove Tape

Installation Guide

Instructions for Installation & First Time Start-up

1. The facility will need to provide the appropriate grounded electrical outlet, hot and cold water supply lines with ½" full port ball valves with ¾" male garden hose fittings for each supply, and a 1.5" diameter drain connection (see system specification of this manual for further assistance). Both the hot and cold facility water lines must be a minimum of ½" ID and must use the Meritech supplied water lines or female x female garden hoses that have a 3/8" minimum ID.
2. Connect the facility drain to the system drain.
3. Connect the facility hot and cold lines to the system hot and cold inlets.
 - **Do not hard pipe to water inlets of the system – Use flexible hoses.**
 - **Facility hot/cold water shut off valves need to be located near the handwashing system for serviceability.**
 - **Hot water supplied to the system must be between 135° - 160°F tanked water source. System is not compatible with tank-less water heaters.**
4. Connect the solution containers (see "changing solutions containers" of this manual).
5. Apply water pressure by opening the facility supplied inlet valves and check for leaks.
6. Connect the power cord(s).
7. Allow the system to run through its Selfclean start-up cycle.
8. Perform several hand wash cycles by blocking the photo optical sensor. Allow enough time for the hot water supply to reach the system.
9. Check for leaks and the system is ready for operation.

THE 2000S STATION IS NOW READY FOR NORMAL HANDWASH OPERATION

Facility Utility Locations

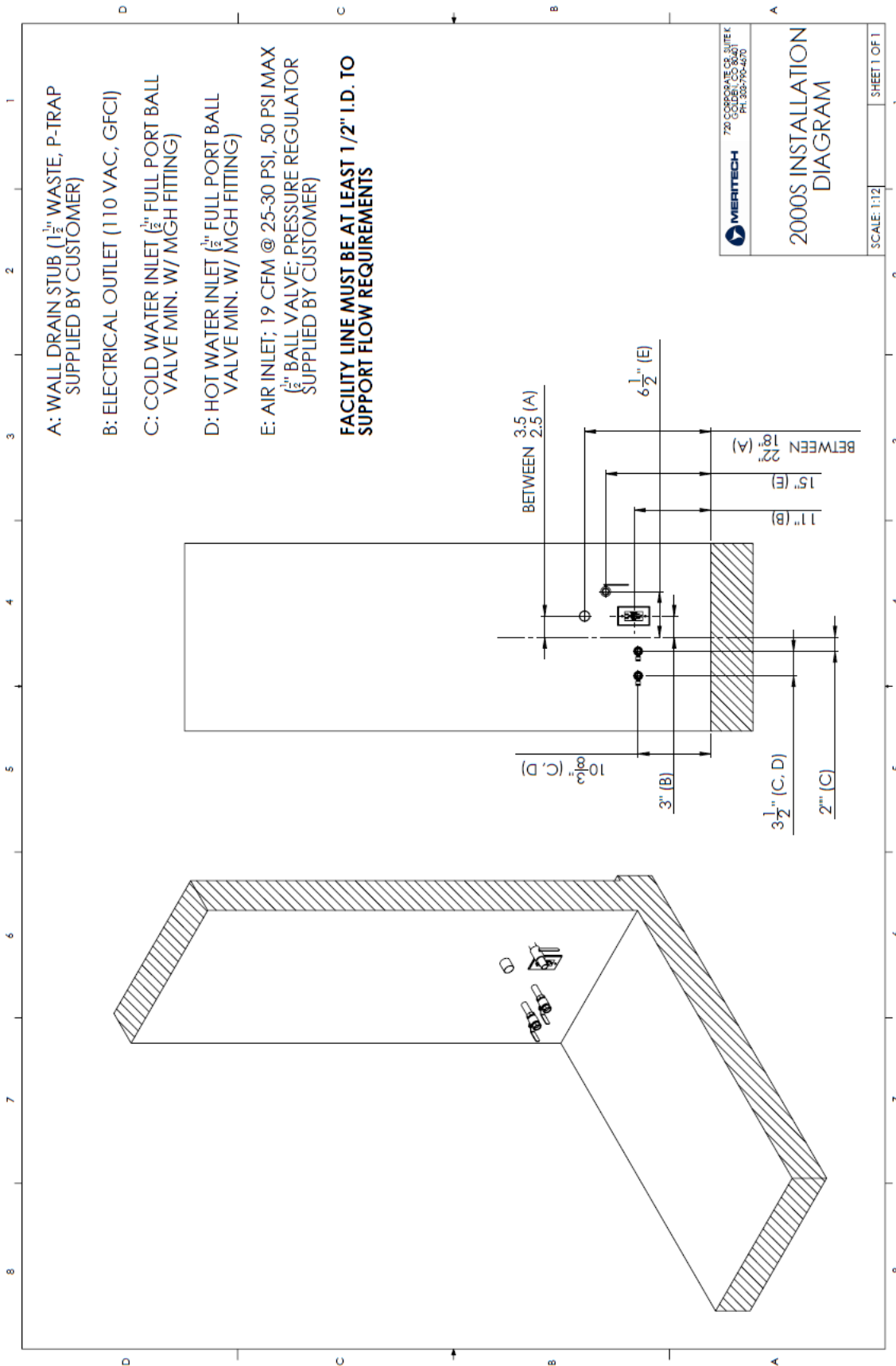

Cut Sheet

Dimensions and Locations for installation

(Vertical dimensions are with the leveling feet in the full up position & can increase by 2" by adjusting feet)

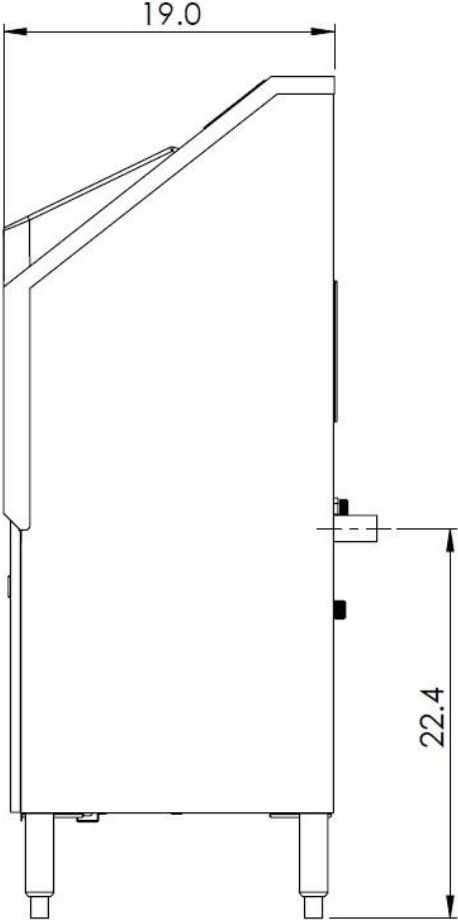
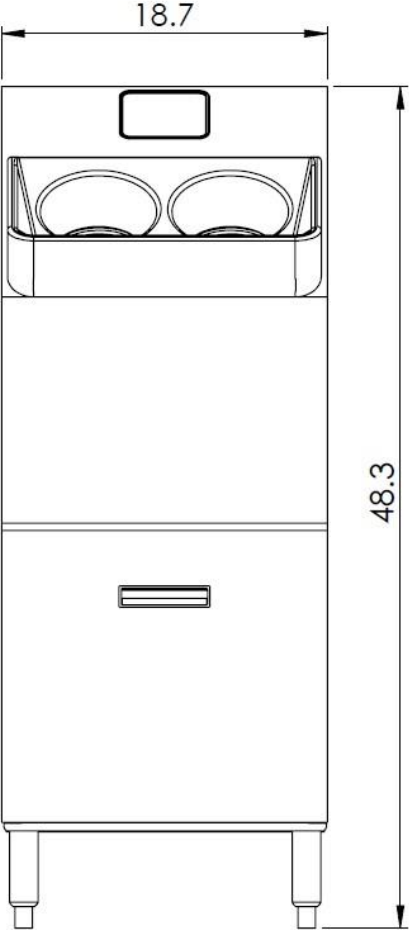

Cut Sheet - Continued

- A. Cold Water Inlet (3/4" male garden hose fitting)
- B. System Drain (1.5" pipe stub, pipe stub sticks out of system 3")
- C. Hot Water Inlet (3/4" male garden hose fitting)
- D. System Power Cord
- E. Adjustable Leveling Foot (6 places, all vertical dimension can increase by 2")
- F. Optional Air Curtain Inlet (1/2" FNPT fitting)

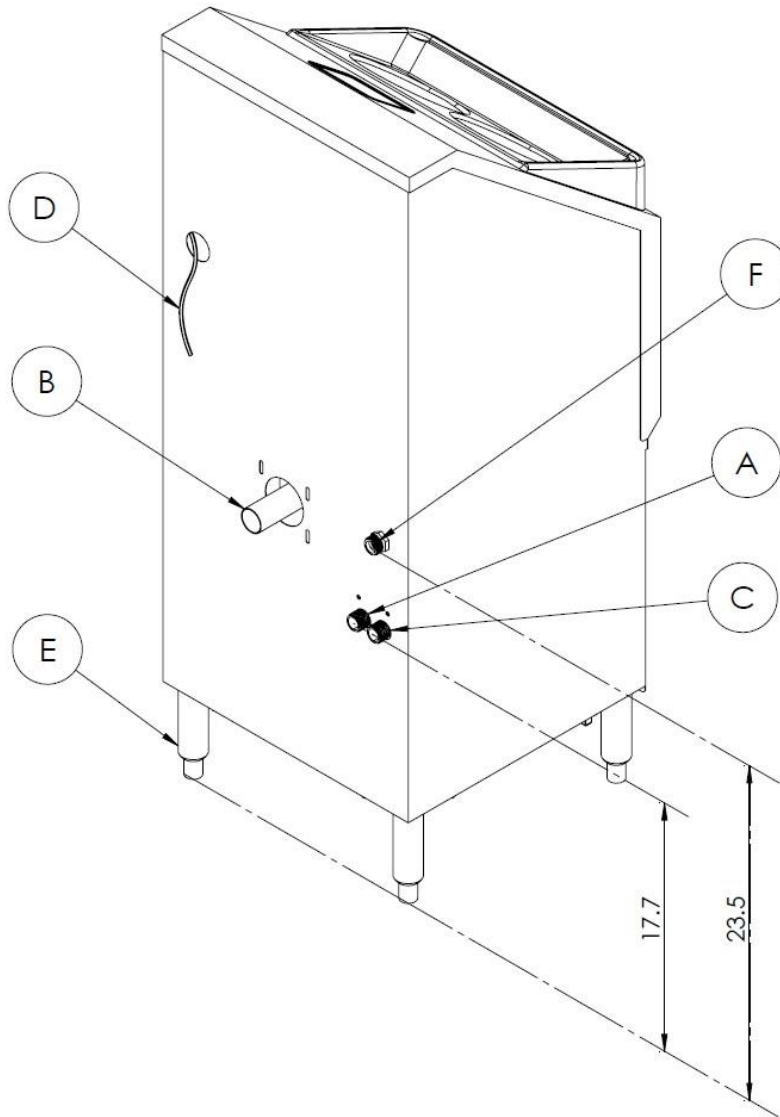

SEE SYSTEM SPECIFICATIONS OF THIS MANUAL FOR DETAILED DESCRIPTION AND FACILITY REQUIREMENTS.

Optional Boot Sanitizing Pan

Please refer to separate 2000S / 2000S Boot Sanitizing Pan Installation and Operation Manual. (See photo below for reference)



Optional Air Curtain

The optional air curtain on the CleanTech 2000S system incorporates an air dryer into the fully automated CleanTech handwashing station. At the end of every wash cycle, the integrated air dryer can completely or partially dry the hands, reducing or eliminating paper towel waste. Ideal for companies seeking a “Greener” footprint, while maintaining sanitary standards that other dryers can’t match because the air is filtered and controlled from a CDA source in the facility.

To operate just place your hands in the middle of the cylinders to activate a handwash. At the completion of the handwash the water will shut off and a compressed air will turn on as long as your hands are blocking the photo electric eye. Move your hands up and down through the air path to dry your hands keeping them blocking the photo electric eye and in the middle of the cylinders. A drip free hand is typical in 3-5 seconds and a dry hand in 25-35 seconds depending on air pressure.

We recommend an external pressure regulator be installed on the system to regulate air pressure between 25-50 PSI when all three bays are in operation. If only one bay is in operation there will be increased air velocity in the air drying. If the hands are not blocking the photo electric eye at the end of the wash, there will be a short blast of air for 2 seconds and shut off and this is a normal operation.

System Specifications

- Features
 - Freestanding, 304 SST construction, NEMA 4X electronics enclosure
 - Designed for high-use areas (4-5 people per minute)
 - CIP model
 - Washes up to Mid-Forearm
 - Integrated Self-Cleaning function – runs 1 time per day
 - Optional Plumbing Cover Shroud (172)
 - Optional Integrated Air Curtain Dryer (2000S-A)
 - Optional Boot Sanitizing Pan 23” W x 23” D (2000S-B)
 - Optional Integrated Air Curtain Dryer & Boot Sanitizing Pan (2000S-AB)
 - Optional Low Moisture Footwear Sanitizing Pan 23” W x 23” D (2000S-SC)
 - Solution/Control cart 12” W x 13” D x 40” H (31 cm W x 33 cm D x 102 cm H)
 - Optional Integrated Air Curtain Dryer & Low Moisture Footwear Sanitizing Pan (2000S-ASC)
 - Optional Turnstile Controlled Access (see separate spec. sheet)
- Dimensions
 - 18 ½” width x 21 1/2” depth x 48 1/2” height + Footwear Pan 23” W x 23” D (in front of system)
 - 47 cm width x 55 cm depth x 123 cm height + Footwear Pan 58.4 cm W x 58.4 cm D (in front of system)
- Weight
 - 87 lbs. (39.5 Kg) – varies with options
- Shipping Weight
 - 140 lbs. (63.5 Kg) – varies with options
- Cycle Activation
 - Handwash – Automatic via infrared photo optical sensor
 - Selfclean – Automatic once per day
 - Master & optional re-settable compliance monitor
- Electrical
 - 100 - 240 VAC 50/60 Hz, 160 Watts – Intl. plugs available
- Solutions Level
 - Solutions level LED light bar indicator / “ULTRAPURE SOL. EMPTY” display notification
 - Selfclean level LED light bar indicator / “SELFCLEAN SOL. EMPTY” display notification
- Self-Cleaning Feature
 - The handwashing station will perform a cleaning cycle 1 time per day
- Water Consumption
 - 0.6 gallon (2.3 L) per handwash cycle
- Plumbing
 - 2 – ¾” male garden hose fitting, hot & cold minimum 4 (15 LPM) GPM flow
 - 40 - 100 PSI (2.8 - 6.9 Bar), 50 PSI (3.6 Bar) optimum water pressure
 - Note: **Consult Meritech if connecting more than 2 system on the same water lines**
- Drain
 - Standard 1 1/2” (40 mm) drain stub, P-Trap to be supplied by facility
 - Ideal wall drain height from floor is 18” – 22” (46 - 56 cm)
 - **Wall & Floor drain required for Boot Sanitizing Pan option**
- Compressed air for Optional Integrated Air Curtain Dryer
 - 3/8” (9.5 mm) inside diameter supply line recommended, 19 CFM at 25-30 PSI (1.7 - 2.0 Bar) for optimal performance. Not to exceed 50 PSI (3.6 Bar). Pressure regulator not supplied. Must be installed external to station.

System Specifications – Continued

- Maintenance
 - Daily, Weekly, & Quarterly (see maintenance section of this manual)
 - As needed (see maintenance section of this manual or contact Meritech for assistance)
- Protective Modes
 - Solutions level indication
 - Solutions empty notification
 - Current limited motor
- Solutions Storage
 - 1 – 2 ½ (10L) gallon container hand hygiene solution – per bay
 - 1 – 1-gallon (3.8L) container Selfclean solution (used for station Self-cleaning cycle & Optional Boot Sanitizing) – per bay
 - 1 – 5-gallon (20L) container Sanifect D2 Solution (Optional Low Moisture Footwear Sanitizing)
- Hand Solution
 - Required solutions provided by Meritech

Solutions provided or approved by Meritech (Other solutions may void warranty)

PATENTS:

CleanTech® Automated Handwashing and Boot washing Systems are protected by the following U.S. Patents: U.S. Pat. No. 5,265,628; U.S. Pat. No. 5,823,447; U.S. Pat. No. 7,607,442; U.S. Pat. No. 7,607,443; U.S. Pat. No. 7,617,830; U.S. Pat. No. 7,641,740; U.S. Pat. No. 7,659,824; U.S. Pat. No. 7,682,464; U.S. Pat. No. 7,698,770; U.S. Pat. No. 7,754,021; U.S. Pat. No. 7,754,022; U.S. Pat. No. 7,757,700; U.S. Pat. No. 7,758,701; and other patents pending.

Consult local and national codes: conformity and compliance to local and national codes is the responsibility of the installer.

Specifications subject to change without prior notice.



If External Backflow Prevention is needed

If your local plumbing code requires or additional backflow prevention is required external to the handwash system, the following backflow preventers are suitable and approved for use with our systems. Two units will be required for each system, one on each the hot and cold inlets.

Consult local and national codes: conformity and compliance to local and nation codes is the responsibility of the installer. Consult your local plumbing code for specific details for your location and use a certified plumber for proper installation.

For ANSI/ASSE Standard 1012 applications:



Zurn/Wilkens Model 760-1/2"

Part Number: 760-1/2"

For ANSI/ASSE Standard 1056 applications:



Watt® Series 008PCQT-1/2"

For details or further assistance on these components, please contact Meritech Customer Service
800.932.7707

Contacting Meritech

If you have questions about the use of the CleanTech® systems, need installation or trouble shooting assistance, or need to purchase additional solution for your system contact us below.

Meritech Systems, LLC
720 Corporate Circle, Suite K
Golden, CO 80401 USA

Phone: (800) 932-7707
Fax: (303) 790-4859

www.meritech.com

E-mail: cleantechinfo@meritech.com

E-mail: service@meritech.com



THE CLEANTECH® 2000S HAS BEEN DESIGNED TO OPERATE SPECIFICALLY WITH THE HANDWASH SOLUTIONS PROVIDED OR APPROVED BY MERITECH. THEY ARE OF A SPECIFIC CONCENTRATION AND VISCOSITY.

WE CANNOT GUARANTEE SATISFACTORY PERFORMANCE NOR WARRANTY THE SYSTEM IF THE CONTAINERS ARE FILLED WITH A DIFFERENT SOLUTION. IN ADDITION, THERE IS ALSO A RISK OF INTRODUCING CONTAMINANTS WHICH WILL BE INCOMPATIBLE WITH THE SYSTEM.

Meritech Systems, LLC Limited Warranty

Meritech Limited Warranty

WARRANTY COVERAGE

"Meritech" refers to Meritech Systems, LLC d/b/a Meritech, the manufacturer of the accompanying product, consumables and accessories sold new by Meritech or an approved distributor of Meritech (collectively, the "Product"). The "Original Purchaser" refers to the original use purchaser of the Product. Meritech's warranty obligations are limited to the terms set forth in this Limited Warranty. If you purchased a product from someone other than Meritech or an approved distributor of Meritech, or if the product was used (including but not limited to floor models or refurbished product) prior to your purchase, you are not the Original Purchaser and the product that you purchased is not covered by this Limited Warranty.

Meritech warrants to the Original Purchaser that the Product shall be free from defects in materials and workmanship for a period beginning on the date that Meritech ships the Product to the Original purchaser and ending on the date that is twelve (12) months thereafter (the "Warranty Period") for parts only. This Limited Warranty does not apply to the following: (a) any third-party products or any third-party operating systems installed in connection with the Product; (b) any component part from which the serial number has been removed or altered; (c) damage or non-functionality that results from (i) failure to follow the instructions that came with the Product, (ii) usage that is not in accordance with the Product instructions, including without limitation, **use of solutions not supplied by Meritech**, (iii) any act of God, vandalism, fire, lightning, smoke, pollution, particulate matter, wind, snow, icing, power surge, electrical power or water abuse, (iv) problems caused by using accessories, parts, or components not supplied by Meritech, (v) failure to perform preventive or proper maintenance, and (vi) servicing not authorized by Meritech; (d) Boot washer or boot scrubber brushes; and (e) any Product for which Meritech has not received payment from the Original Purchaser.

If a defect exists to the Product, the Original Purchaser's sole remedy is to make a warranty claim within the Warranty Period, and Meritech's sole liability shall be to, at Meritech's election: (a) repair the Component Parts at no charge, using new and refurbished parts; or (b) replace the Product with a product that is new or which has been manufactured from new and serviceable used parts and is at least functionally equivalent to the original Product. A replacement part/product assumes the remaining Warranty Period of the original Product or thirty (30) days from the date of replacement or repair, whichever provides longer coverage to the Original Purchaser. When a product or part is exchanged, any replacement item becomes the Original Purchaser's property and the replaced item becomes Meritech's property. Any suspected defect shall be subject to inspection and confirmation by Meritech.

To the extent assignable, Meritech assigns to the Original Purchaser all transferable warranties (and remedies extended thereunder) that have been extended to Meritech by the manufacturers of any of the component parts and, after expiration of the Warranty Period, the Original Purchaser agrees to look solely to such manufacturers with regard to any warranty claims and remedies relating to the Product.

WARRANTY DISCLAIMER

MERITECH'S RESPONSIBILITY FOR DEFECTS IN THE PRODUCT IS LIMITED TO REPAIR OR REPLACEMENT, AT MERITECH'S ELECTION, AS SET FORTH IN THIS LIMITED WARRANTY. EXCEPT AS EXPRESSLY SET FORTH IN THIS LIMITED WARRANTY AND SUBJECT TO THE FOREGOING, MERITECH DOES NOT MAKE OR EXTEND, AND THE ORIGINAL PURCHASER ACKNOWLEDGES THAT MERITECH HAS NOT MADE OR EXTENDED, AND MERITECH HEREBY DISCLAIMS FOR ALL PURPOSES, ANY AND ALL OTHER REMEDIES, REPRESENTATIONS, WARRANTIES OR COVENANTS, EXPRESS OR IMPLIED WITH RESPECT TO THE PRODUCT, INCLUDING WITHOUT LIMITATION, ALL WARRANTIES OF MERCHANTABILITY, FITNESS FOR ANY PARTICULAR PURPOSE, PERFORMANCE, CONDITION, DESIGN, APPLICATION, NON-INFRINGEMENT, USE AND/OR DURABILITY. IF MERITECH CANNOT LAWFULLY DISCLAIM IMPLIED WARRANTIES UNDER THIS LIMITED WARRANTY, ALL SUCH WARRANTIES, INCLUDING WARRANTIES OF MERCHANTABILITY AND FITNESS FOR A PARTICULAR PURPOSE ARE LIMITED IN SCOPE TO THE EXTENT POSSIBLE AND IN DURATION TO THE DURATION OF THIS LIMITED WARRANTY. No statement, affirmation or other representation, whether by words or action, of Meritech, its agents, employees or representatives that are not explicitly provided in this Limited Warranty shall constitute a warranty.

LIMITATION OF LIABILITY

Notwithstanding anything herein or otherwise to the contrary, express or implied, Meritech's liability for any claim or action of any kind arising out of, in connection with or resulting from the manufacture, sale, delivery, resale, use or repair of the Product shall not exceed the total cost of the Product. Meritech shall not be liable for errors, costs, or expenses which may be incurred in its performance of its obligations hereunder which results from Meritech's reliance upon information furnished by the Original Purchaser. MERITECH SHALL NOT BE LIABLE TO ORIGINAL PURCHASER UNDER ANY CIRCUMSTANCES FOR ANY SPECIAL, CONSEQUENTIAL, INCIDENTAL OR PUNITIVE DAMAGES ARISING OUT OF OR IN ANY WAY CONNECTED WITH THIS LIMITED WARRANTY OR THE PRODUCT, INCLUDING BUT NOT LIMITED TO DAMAGES FOR LOST PROFITS, LOSS OF USE, OR FOR ANY DAMAGES OR SUMS PAID BY THE ORIGINAL PURCHASER TO THIRD PARTIES EVEN IF MERITECH HAS BEEN ADVISED OF THE POSSIBILITY OF SUCH DAMAGES. THE FOREGOING LIMITATION OF LIABILITY SHALL APPLY WHETHER ANY CLAIM IS BASED UPON PRINCIPLES OF CONTRACT, WARRANTY, NEGLIGENCE OR OTHER TORT, BREACH OF ANY STATUTORY DUTY, PRINCIPLES OF INDEMNITY OR CONTRIBUTION.

Some states do not allow the exclusion or limitation of incidental or consequential damages, so the above limitations or exclusions may not apply.

WARRANTY SERVICE AND OTHER TERMS

Meritech reserves the right to make changes or improvements to Meritech's products, consumables or accessories from time to time without incurring the obligation to install or implement such improvements or changes on products, consumables or accessories previously manufactured.

Meritech shall be under no obligation to sell replacement parts for, or provide maintenance or other services on, any products, consumables or accessories with respect to which this Limited Warranty does not apply, has expired or has otherwise been voided.

This Limited Warranty gives the Original Purchaser specific legal rights and you may also have other rights which may vary from state to state.

To obtain warranty service under this Limited Warranty during the Warranty Period, please contact our service department at 1-800-932-7707 or service@meritech.com, or visit our website at www.Meritech.com.

Terms & Conditions of Sale

Standard Terms and Conditions of Sale For Customers

SCOPE: These Terms and Conditions apply to all sales made by Meritech Systems, LLC ("Meritech"), and its Meritech Division. These Terms and Conditions apply in lieu of any course of dealing between the parties or usage of trade in the industry.

TERMS: Buyer agrees to pay for the products, including all component parts, specified on this invoice (the "Product") in accordance with the payment terms specified on this invoice. In the event Buyer fails to make any payment to Meritech when due, Buyer's entire account(s) with Meritech shall become immediately due and payable without notice or demand. All past due amounts shall bear interest from the due date until paid at a rate of 18% per annum. If Buyer fails to pay any amounts outstanding within 10 days of such due date, Meritech may elect to enter Buyer's principal place of business and any other location where the Product is located and remove the Product. The costs of such removal shall be borne solely by Buyer, and Buyer shall indemnify Meritech and hold Meritech harmless from any damages or other liabilities arising from such removal. The foregoing remedies are in addition to, and not a substitute for, any other remedies provided for herein or that may otherwise be available to Meritech.

SHIPMENTS: All products are shipped F.O.B., point of shipment unless otherwise agreed to in writing by Meritech. Risk of loss shall transfer to the Buyer upon tender of goods to Buyer, Buyer's representative, or common carrier. The cost of any special packing or special handling caused by Buyer's requirements or requests shall be added to the amount of the order. If Buyer causes or requests a shipment delay, or if Meritech ships or delivers the products erroneously as a result of inaccurate, incomplete or misleading information supplied by Buyer or its agents or employees, storage and all other additional costs and risks shall be borne solely by Buyer. Claims for products damaged or lost in transit should be made by Buyer to the carrier, as Meritech's responsibility ceases upon tender of goods to Buyer, Buyer's representative or common carrier.

INSPECTION AND ACCEPTANCE: Claims for damage, shortage or errors in shipping must be reported within three days following delivery to Buyer. Buyer shall have 7 days from the date Buyer receives the Product to inspect the Product for defects and nonconformance that are not due to damage, shortage or errors in shipping and notify Meritech, in writing, of any defects, nonconformance or rejection of the Product. After such 7 day period, Buyer shall be deemed to have irrevocably accepted the Product and these Terms and Conditions. After such acceptance, Buyer shall have no right to reject the Product for any reason or to revoke acceptance, or to dispute any of these Terms and Conditions. Buyer hereby agrees that such 7 day period is a reasonable amount of time for such inspection and revocation of the Product. Buyer shall have no right to order any change or modification to the Product or service previously ordered by Buyer or its representatives. Specially fabricated or ordered items may not be returned, and no refund will be made. The sole and exclusive remedy for any alleged defect in workmanship or material will be the replacement of the Product subject to Meritech's inspection and limited warranty.

TAXES: Buyer shall be liable for the payment of all transaction based taxes including without limitation sales, use, gross receipts, compensating, occupation, privilege, excise or other similar taxes assessed in connection with the purchase and sale of the Product by payment of such taxes to Meritech, or by executing and delivering to Meritech a tax exemption certificate or in those jurisdictions where Meritech is not required to administer the laws and regulations of such jurisdiction, a tax indemnification agreement. Any such tax exemption certificate or tax indemnification agreement shall be in form and substance acceptable to Meritech, in Meritech's sole discretion. Meritech shall have no obligation to pay any taxes, which are Buyer's sole responsibility.

SECURITY INTEREST: Buyer hereby grants Meritech, to secure the payment and performance in full of the purchase price for the Product, plus any fees owed hereunder, a continuing security interest in, and pledges to Meritech, the Product (the "Collateral"), wherever located, whether now owned or hereafter acquired or arising, and all proceeds thereof. Buyer represents, warrants, and covenants that the security interest granted herein is, and shall continue to be, a first priority perfected security interest in the Collateral so long as any portion of the purchase price and fees remains unpaid. Meritech's security interest in the Collateral shall continue until the purchase price and fees have been paid in full. Upon such payment in full, Meritech shall release its security interest in the Collateral and all rights therein shall revert to Buyer. Buyer hereby authorizes Meritech to file financing statements, without notice to Buyer, in all appropriate jurisdictions that, in Meritech's sole judgment, are reasonably necessary to perfect or protect Meritech's interest or rights hereunder.

TITLE: Title to the Product shall remain with Meritech until Buyer has paid the entire purchase price and any fees owed hereunder.

LIMITED WARRANTY: Meritech makes no warranties with respect to the Product other than those expressly provided in Meritech's Limited Warranty available on its website at www.meritech.com.

INDEMNIFICATION: Buyer agrees to protect, indemnify, hold harmless and defend Meritech and its members, managers, officers, affiliates, agents and employees against any and all losses, damages, claims, lawsuits, demands, causes of action, judgments, liabilities and expenses (including attorneys' fees and related costs) for injury to or death of any persons (including without limitation Buyer, Buyer's customers, Buyer's employees and agents, or any employee or agent of them, Buyer's co-venturers, contractors, subcontractors and suppliers) or damage to or loss of any property or the environment, or violation of any applicable laws or regulations arising in any manner, directly or indirectly, out of or in connection with, or in the course of or incidental to any of Buyer's use, application or operation of the Product, regardless of cause or of any fault or negligence of Meritech or Meritech's agents.

FORCE MAJEURE: The obligations of Buyer and Meritech shall be suspended and neither shall be liable for any damages suffered by the other if the failure of Buyer or Meritech to perform arises from an event of Force Majeure. An "event of Force Majeure" includes acts of God, weather or other action of the elements, warlike action, insurrection, revolution, civil strife, piracy, civil war, hostile action, strikes or other labor stoppages, acts of public enemies or material changes to state, federal or local laws, rules or regulations. Lack of funds or financial resources shall not be considered an event of Force Majeure.

REPRESENTATIONS AND WARRANTIES OF BUYER: Buyer represents and warrants to Meritech that (a) the information set forth on this invoice accurately represents (i) Buyer's exact legal name; (ii) Buyer's form of organization and jurisdiction of organization; (iii) Buyer's principal place of business or executive offices and, if different, mailing address; and (iv) all other information set forth in this invoice pertaining to Buyer is accurate and complete, and (b) Buyer has sufficient financial resources to pay its debts and other financial obligations (including trade debts) as they come due, including the obligation to pay the purchase price and any fees owed hereunder to Buyer.

COVENANTS: So long as any portion of the purchase price or fees payable to Meritech hereunder remain unpaid, (a) Buyer shall not, without at least 30 days prior written notice to Meritech: (i) change its jurisdiction of organization, (ii) change its organizational structure or type, (iii) change its legal name, or (iv) change its tax identification number or other organizational number (if any) assigned by its jurisdiction of organization, (b) Buyer shall maintain the Product and keep the Product in good repair and working condition, and (c) Buyer shall not convey, sell, lease, transfer or otherwise remove the Product from Buyer's facilities, without the prior written consent of Meritech.

DEFAULT: Meritech may enter Buyer's principal place of Business upon prior written notice, and any amounts outstanding as of the date thereof, including without limitation, accrued interest, shall become immediately due and payable if Buyer (a) breaches any covenant, obligation, or warranty specified herein, (b) fails to make any payment due hereunder or pay any other obligations after such obligations are due and Meritech has provided Buyer with notice of such default, (c) becomes insolvent, enters into bankruptcy or a receiver is appointed in respect of any of its business or Buyer makes an assignment for the benefit of creditors, or (d) breaches any other provision of these Terms and Conditions.

ENFORCEMENT: The exclusive forum for adjudication of any controversy or dispute relating to the interpretation of or performance under or any matter relating to these Terms and Conditions or the Product shall be the state or federal courts located in the City and County of Denver, Colorado. Buyer waives any objection which it may now or hereafter have to such venue of any such action, suit or proceeding or any claim of forum non conveniens, and irrevocably submits itself to the nonexclusive jurisdiction of any such state or federal court for the purposes of any such action, suit or service proceeding.

WAIVER: Any waiver by Meritech of these Terms and Conditions or any defaults hereunder shall not constitute a waiver of the remaining Terms and Conditions or of any partial invalidity or unenforceability, and no failure or delay in exercising any right hereunder shall operate as a waiver thereof.

SEVERABILITY: If any provision hereof is held to be illegal, invalid or unenforceable under any present or future laws, such provision shall be fully severable and the terms and conditions herein shall be construed and enforced as if such illegal, invalid or unenforceable provision had never been made a part hereof. The remaining provisions herein shall remain in full force and effect and shall not be affected by such illegal, invalid or unenforceable provisions or by their severance here from.

GOVERNING LAW: This transaction shall be governed in all respects by the laws of the State of Colorado, without regard to its conflict of laws provisions. THE U.N. CONVENTION OF CONTRACTS FOR THE INTERNATIONAL SALES OF GOODS SHALL NOT GOVERN NOR APPLY TO ANY MATTERS ADDRESSED HEREIN OR RELATED HERETO.

SUCCESSORS AND ASSIGNS: These Terms and Conditions and everything herein contained shall inure to the benefit of and be binding upon Buyer, Meritech and each of their heirs, executors, administrators and permitted successors and assigns.

ENTIRE AGREEMENT: This document constitutes the entire, complete, and exclusive agreement between Buyer and Meritech with respect to the subject matter hereof. All prior proposals, negotiations and representations, if any, including any purchase orders or written quotes, that are different from or in addition to the terms and conditions herein are hereby rejected and shall not be binding on Meritech.