

# CleanTech.<sup>®</sup> EVO One



**MERITECH**

Installation & Operation Manual

# Installation & Operation Manual

## CleanTech® EVO One Automated Handwashing Station

### Manufactured by:

Meritech Systems, LLC  
720 Corporate Circle  
Suite K  
Golden, CO 80401 USA

### Contact Us:

Phone: (800) 932-7707  
Fax: (303) 790-4859  
Email: [support@meritech.com](mailto:support@meritech.com)  
Website: [www.meritech.com](http://www.meritech.com)

**WARNING:** The performance and effectiveness of CleanTech® Automated Handwashing Stations have been extensively tested when using the hygiene solutions provided by Meritech Systems, LLC. Satisfactory performance or effectiveness of the CleanTech® Station cannot be guaranteed when other chemicals are used.

**FAILURE TO USE MERITECH SYSTEMS, LLC SUPPLIED CHEMICALS WILL VOID ANY AND ALL WARRANTIES**



# Table of Contents

<b>Introduction</b>	<b>4</b>
Help & Support	4
Achieving the Perfect Hand Wash	5
Helpful Pointers for Trouble-Free Operation	6
Optional CleanTech® Enhancements for this EVO Station	7
<b>Section 1: Unpacking &amp; Installing this EVO Station</b>	<b>9</b>
Specifications	9
Handwash Temperature Control & Backflow Prevention	12
Unpacking & Installing this EVO Station	13
Cut Sheets & Installation Rough-In Diagrams	14
Enhancement Installation Instructions & Cut Sheets	16
<b>Section 2: Installing &amp; Using Hygiene Solutions</b>	<b>22</b>
Importance of Using Meritech Hygiene Solutions	22
Installing Hygiene Solution Cartridges	23
<b>Section 3: How to Use the Display Touchscreen</b>	<b>24</b>
Station Setup Screens	24
Hygiene Solution Installation & Setup Screens	28
Using the Display Touchscreen	31
Administrative Area of the Touchscreen Display	34
<b>Section 4: Maintenance &amp; Components of this EVO Station</b>	<b>45</b>
Cleaning & Maintenance Instructions for this EVO Station	45
Enhancement Cleaning & Maintenance Instructions	46
Major Components of this EVO Station	49
<b>Section 5: Warranty and Terms &amp; Conditions of Sale</b>	<b>55</b>

# Introduction

Getting started with your EVO One

## Digital Owner's Guide

Did you know that we have an entire library full of videos, downloadable documents other resources to assist with installing, onboarding, and training, audits and maintaining your new automated hygiene equipment in our [online Digital Owner's Guide](#)? Check it out using the QR code to the right!



Thank you for joining the hygiene revolution and choosing to use CleanTech® EVO Automated Handwashing Stations to ensure hygiene excellence at your facility! We designed the CleanTech EVO series to provide your facility with an automated, state of the art system that meets or exceeds your hand washing requirements for compliance, standardization, and effectiveness. This manual describes everything you will need to properly install, use, and maintain your new CleanTech® system. Before you dive in, here's some important information you need to know:

## Help & Support

The first thing you need to know about us is that we're more than just an equipment manufacturer. When you partner with Meritech, our hygiene experts are here to help make sure that you have everything you need for hygiene excellence at your facility, starting with choosing the perfect place for your new automated hygiene equipment.

One of the most important parts of installing a CleanTech® station is choosing the right area for it at your facility. Select an area for installation that encourages frequent use for maximum hygiene compliance. We recommend positioning the CleanTech® station in the main work area, lunch facilities, restroom facilities, and close to the entrance and exit doors. If you need assistance designing your hygiene zone or selecting the perfect place to install your system, please contact us for a hygiene zone consultation at: <https://www.meritech.com/hygiene-zone-design-consultation>

If you need any help with your CleanTech® station, our Colorado-based support team is just a phone call or email away! Contact them anytime Monday through Friday 8am-5pm MT at: (800) 932 7707 or [support@meritech.com](mailto:support@meritech.com)

# Achieving the Perfect Hand Wash

The CleanTech® EVO system provides a no-touch, completely automatic hand wash by sequentially delivering handwashing solution and water in a stimulating spray to the hands or gloves from fingertips to wrist. The system uses the UPX - UltraPure hand hygiene solution and water to remove more than 99.9% of pathogens from hands or gloves. The system can also remove particles, allergens, sodium's and other contaminants.

The standard system configuration is 12 seconds which consists of a PRIME Cycle, WASH cycle, and Final RINSE to thoroughly clean and sanitize the hand in the simplest way. A helical configuration of jet nozzles located within the two rotating cylinders is used to spray the mixture of solutions and pressurized water onto the hands followed by a potable water rinse.

To minimize cross-contamination, an infrared photo optical sensor positioned directly above the cylinders automatically senses the presence of your hands when they enter the cylinders. This activates the wash cycle; it will not be necessary to touch any part of the system; simply insert your hands into the cylinders. One complete hand wash cycle will automatically dispense the appropriate volume of hygiene solution followed by a potable water rinse. The minimum time interval between user cycles is approximately 2 seconds.

Designed together to create the perfect handwash

Solutions – importance – the mechanical engineering combined with chemistry to create the ultimate hand wash

The CleanTech® EVO system utilizes proprietary solutions cartridges for both the UP<sub>x</sub> – UltraPure Hand Hygiene solution and the optional SelfClean<sub>x</sub> System Cleaning Hygiene Solution. These solutions have both been specifically engineered to work with the CleanTech® system for optimum performance. The solution delivery system is designed to give each user the exact same amount needed for CleanTech® to remove more than 99.9% of pathogens during the automated hand wash.

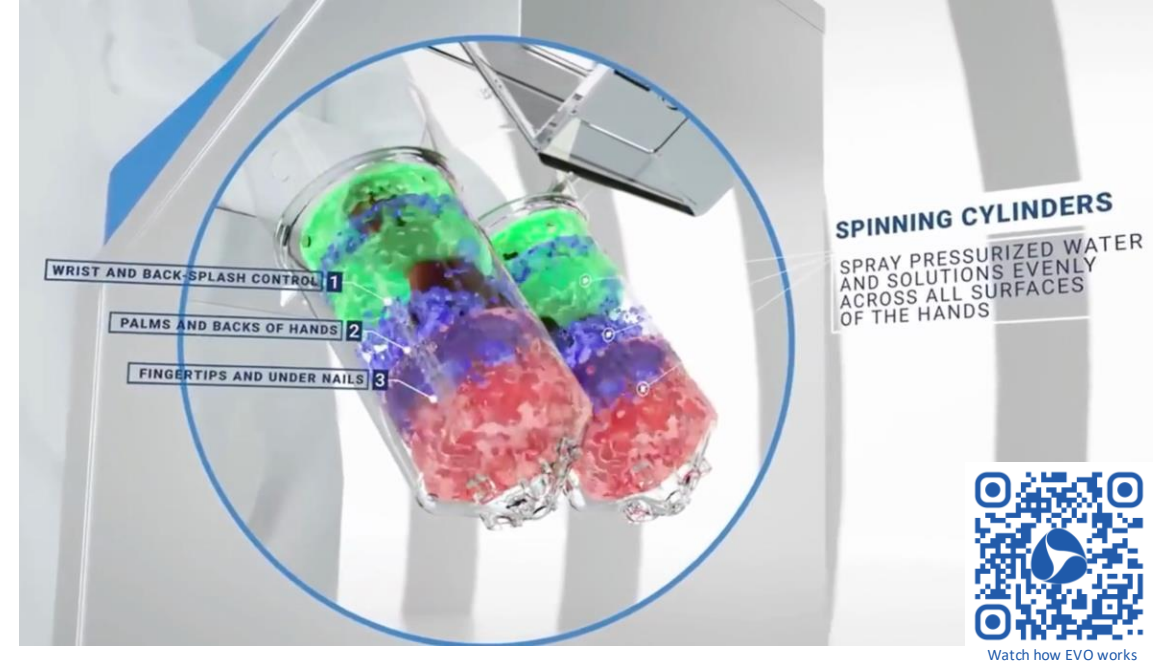

# Helpful Pointers for Trouble Free Operation

- Avoid touching or resting your hands and forearms on the cylinders themselves. If you apply pressure to the cylinder walls, the cylinders have been designed to stop spinning and will restart once you have stopped impeding their rotation.
- Occasionally you may encounter a condition where you have placed your hands into the cylinders, but nothing happens. This condition generally occurs when the next cycle is requested before the previous wash cycle is completed or the hands are not in the centers of the cylinders and blocking the photoeye sensors. To reset the cycle, simply remove your hands, wait for 3 seconds and reinsert your hands into the center of the cylinders.
- During periods of infrequent use, the water temperature may cool. This will have no effect on the quality of the hygiene event and the wash you will receive. The UltraPure Hand Hygiene Solution is designed to work with CleanTech® to properly remove pathogens through a broad range of temperatures. The time it takes for the warm water to return to the station will depend on the distance of the hot water source from the station. In extreme cases or in cold environments, it may be beneficial to have a booster water heater near the system.
- CleanTech® EVO Stations have been designed to be left in the power "on" mode over normal periods of operation. During extended periods of time (3 months or longer) when the system will not be used, we recommend contacting Meritech Support at [support@meritech.com](mailto:support@meritech.com) or 800-932-7707 for assistance in prepping the station for this unused period of time.

## Self Clean

This EVO station includes a Self Clean cycle that initiates automatically on a factory preset schedule at 3 AM (or customized time) and dispenses a sufficient amount of the SelfCleanX hard surface cleaner to eliminate microorganisms and hardwater deposits from the hand wash cylinders, internal basin, and through to the facility drain. The Self Clean cycle will initiate once per day. Each SelfCleanX cartridge will last approximately 60 days.

For information on installing the SelfClean<sub>x</sub> cartridge, please see page: 23

# Optional CleanTech® Enhancements for this EVO Station

## Controlled Access Turnstile

*Can be equipped with either boot dip or sole clean as well*

The controlled access turnstile will remain closed until the successful completion of a hand wash cycle using the CleanTech® Automated Handwashing Station, thus guaranteeing a proper hand hygiene event prior to entering a controlled zone. If installed at each entryway, food safety managers, inspectors, and auditors can have peace of mind that every person entering the facility has clean hands for food safety. The compact design makes it extremely versatile and easy to clean and maintain.

For controlled access turnstile installation instructions see page: 20



## Air Curtain

At the end of every wash cycle, a curtain of air blows air on to the hands to partially dry them, reducing paper towel waste. This enhancement is ideal for companies seeking a “greener” footprint. The integrated air curtain for the CleanTech® Handwashing Stations uses the facility's CDA source (compressed air) to maintain sanitary standards that other air dryers can't match.

The optional air curtain enhancement on the system will automatically turn on at the end of the cycle and blow compressed air on to the hands as long as the photoeye is blocked or it can be programmed to run for a set length of time. The air curtain can be used to remove a majority of the water drops in just about 3 seconds or to completely dry the hands in approximately 35 seconds.

The air curtain needs a 3/8" inside diameter supply line, 19 SCFM at 25-30 for optimal performance, not to exceed 50 PSI. Pressure regulator is not supplied. May be installed external to system.

# Optional CleanTech® Enhancements for this EVO Station



## Sole Clean Low Moisture Sanitizing Pan

For dry and semi-dry facilities, as well as areas without a floor drain, the Sole Clean Low Moisture Footwear Sanitizing Pan attaches to the CleanTech® Automated Handwashing Station to sanitize any style of footwear in just 12 seconds. This new sole sanitizer hygiene technology features the automated application of an alcohol-quat chemical blend which sanitizes and then evaporates quickly post application to reduce moisture accumulation around the system. Designed to eliminate the risk of cross-contamination from footwear, it provides a full employee hygiene protocol that is cGMP and compliant with all food safety standards and regulations.

Solutions wall-mounted basket provided/available to keep solutions container for the sole clean off the floor.

For Sole Clean pan installation instructions see page: 16

## Wetted Boot Dip Footwear Sanitation Pan

This boot dip footwear sanitizing pan attaches to our industrial CleanTech® Automated Handwashing Stations to guarantee simultaneous pathogen removal from both hands and footwear. The fully automated shoe sanitizing pan recharges during every hand wash with the system releasing additional sanitizing chemical to maintain PPM at a consistent and effective “kill”-level, controlled between 800-1000 PPM as recommended by food safety organizations.

For Wetted Boot Dip pan installation instructions see page: 18





# Section 1

Unpacking & Installing this EVO Station

Downloadable Spec Sheet

[Download the spec sheet for the EVO One](#) by scanning the QR code to the right or reaching out to the Meritech support team at [support@meritech.com](mailto:support@meritech.com)



## Specifications

Before we get started, let's review the specifications for the CleanTech® EVO One Automated Handwashing System. For a list of parts, please contact the Meritech support team at [support@meritech.com](mailto:support@meritech.com)

### Features

- Touch Screen Display
- Countdown Timer
- Compliance Counter
- Hygiene Event Tracking
- Automatic Warm Up
- Trouble Notification
- Auto Calibration
- Service Notification
- Temperature & Pressure Monitoring
- Solution Remaining %
- On Board Training Videos

### Dimensions

- 47 1/8" H x 18 1/2" W x 21" D

### Weight

- 105 lbs. (47.6 Kg) – varies with options

### Shipping Weight

- 115 lbs. (52.1 Kg) – varies with options

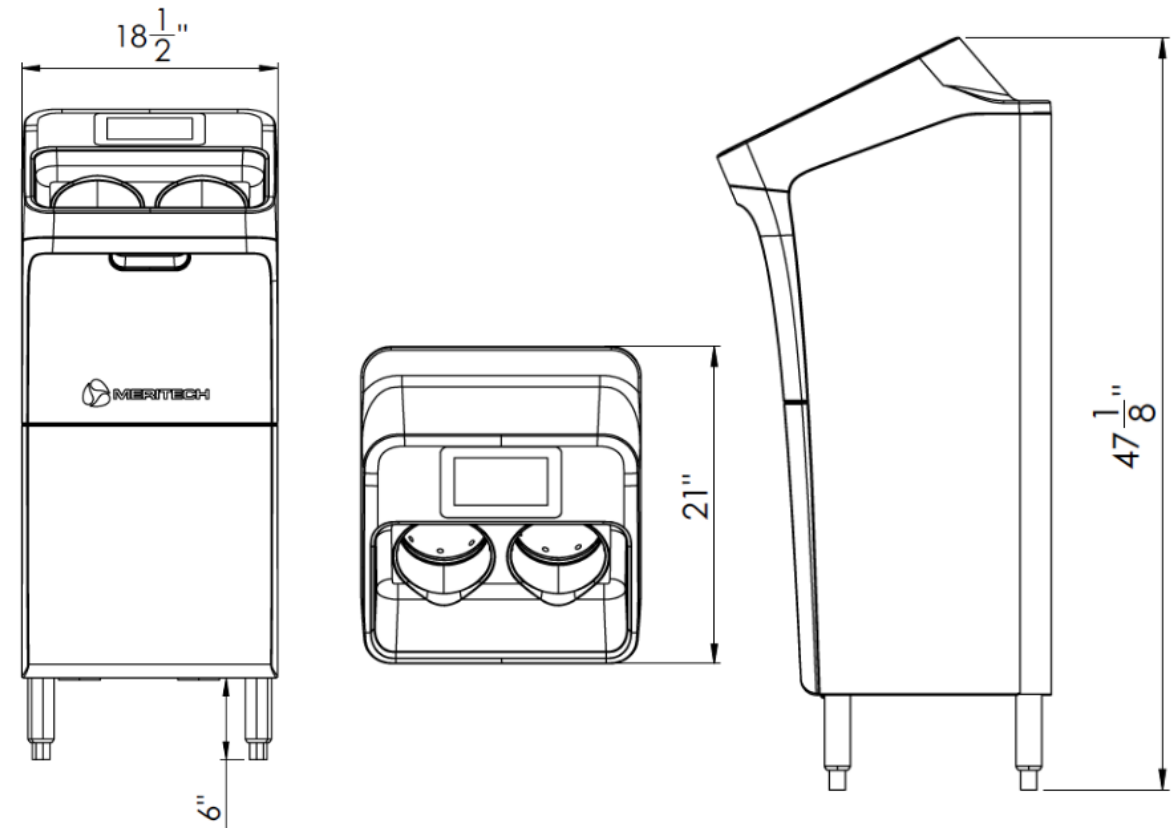

### Cycle Activation

- Handwash – Automatic via infrared photo optical sensor
- SelfClean (optional) – Automatic every 24 hours – Programable for start time (standard is 3 AM)

### Electrical

- 6' Power cord, 100 - 250 VAC, NEMA 5-15p- 3.2-amp fuse - Intl. plugs available
- 84 Watts Consumption (.7 amps)

### Solutions Level

- Solutions level % remaining is displayed on the HOME screen
  - For both UltraPure Solution & Optional SelfClean Solution
  - System will not operate if the UP<sub>x</sub> solutions cartridge is EMPTY

### Water Consumption

- .7 gallon per 12 Second automated hand wash cycle

### Plumbing

- 1/2" MNPT H&C - ASSE 1070 Thermostatic Mixing Valve
- Cold Temp = 40° - 80° F/Hot Temp = 120° - 180° F
- 35 - 100 PSI / 4 GPM minimum (3/8" ID supply line Min.)
- Water Supply Hoses Included
- Backflow preventor – ASSE 1024
- Note: Consult Meritech if connecting more than 2 system on the same water lines

### Drain

- 1 1/2" Slip Drain P-Trap Included
- Ideal wall drain height from floor is 18" (45.7 cm)
- If equipped with boot dip, floor drain will be required

### Compressed Air (for optional integrated air curtain enhancement)

3/8" (9.5 mm) inside diameter supply line recommended., 19 CFM at 25-30 PSI (1.7 - 2.0 Bar) for optimal performance. Not to exceed 50 PSI (3.6 Bar). Pressure regulator not supplied. Must be installed external to station.

**AUTOMATED HANDWASHING SYSTEM**  
MODEL CleanTech®

CE FC

EVO In-Counter  
EVO Wall  
EVO One

Electrical: 100-240 VAC 50/60 Hz, 84 Watts  
NEMA 5-15p, 3.15 Amp Fuse

Water Inlet: 35-100 PSI (2.4 - 6.9 BAR)  
4 GPM Min. (15 LPM Min.)  
3/8" ID Supply Line (9 mm)  
Cold Water = 40°-80°F (4°-27°C)  
Hot Water = 120°-180°F (49°-82°C)

Drain: 1 1/2" Drain Line (38 mm)  
P-Trap or Air Gap Required

Air Inlet  
If Equipped: 25-30 PSI (1.7-2.1 BAR) Operating  
50 PSI Max. (3.5 BAR)  
19 CFM (.54 M<sup>3</sup>/Min.)  
3/8" ID Supply Line (9mm)

ASSE 1070 & ASSE 1024  
Current Limited / Auto Temp. Shutdown

MERITECH SYSTEMS, LLC      MADE IN USA

## Maintenance

- Daily, Weekly, & Quarterly (see maintenance section of this manual)

## Protective Modes

- Depleted Solutions
- Solution Locking Door - optional
- Keyed Solutions Containers
- Solutions Lockout
- Thermostatic Mixing Valve
- Over temperature Shutdown
- Pressure Regulator,
- Backflow Preventor
- Current Limited Motor

## Solutions Storage

- 2,000 ml UP<sub>x</sub> Hand Hygiene Solution (2,000 Hygiene Events)
- 2,000 ml SelfClean<sub>x</sub> System Cleaning Solution (Approx. 60 days)

## Hygiene Solutions

- Meritech hygiene solutions are required

## Internet

- Compatible - with WIFI or Ethernet
- Ethernet - LAN / WEP / WPA / WPA 2/3

## Patents

CleanTech® Automated Handwashing and Boot washing Systems are protected by one or more of the following United States and International Patents:

U.S. Pat. No. 5,265,62

U.S. Pat. No. 7,617,830

U.S. Pat. No. 7,682,464

U.S. Pat. No. 7,754,022

U.S. Pat. No. 5,823,447

U.S. Pat. No. 7,641,740

U.S. Pat. No. 7,698,770

U.S. Pat. No. 7,757,700

U.S. Pat. No. 7,607,442

U.S. Pat. No. 7,659,824

U.S. Pat. No. 7,754,021

U.S. Pat. No. 7,758,701

U.S. Pat. No. 7,607,443

U.S. Pat. No. 11,602,257

And other patents pending.

## Important Information:

Codes varies from municipality to municipality, Meritech has designed in the devices listed above to meet most jurisdictions. Conformity and compliance to local and national plumbing / health departments regulations regarding backflow prevention is the responsibility of the installer.



# Handwash Temperature Control & Backflow Prevention

Your CleanTech® station is equipped with the following safety devices to meet regulatory compliance:

ASSE 1070  
Thermostatic Mixing Valve



ASSE 1024  
Backflow Preventor



## Additional Backflow Prevention:

If additional backflow prevention is required by your local municipality, the below device is approved by Meritech and may be installed external to the system

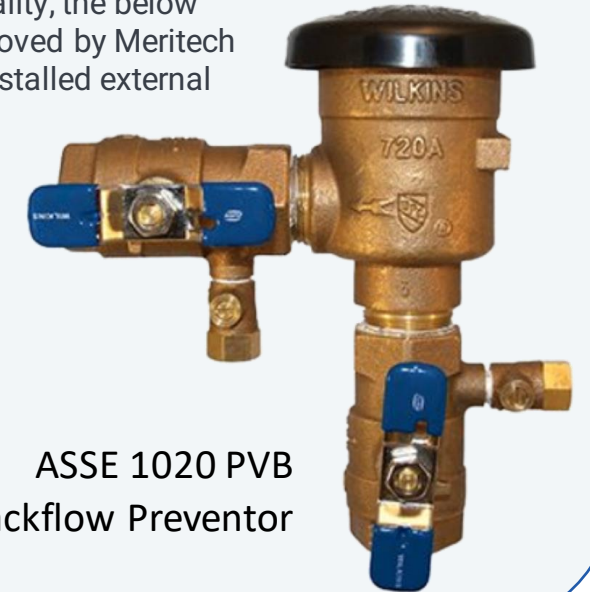

ASSE 1020 PVB  
Backflow Preventor

Codes varies from municipality to municipality, Meritech has designed in the devices listed above to meet most jurisdictions.  
Conformity and compliance to local and national plumbing / health departments regulations regarding backflow prevention is theresponsibility of the installer.

# Unpacking & Installing this EVO Station

## Unpacking the EVO Station

To unpack your EVO Station, carefully follow the instructions depicted on the sides of the box. Be careful when cutting tape and opening packaging to prevent damage of inside components. For additional information on how to unpack your CleanTech station, reach out to the Meritech support team at 1 (800) 932-7707.

### Important Information:

Codes varies from municipality to municipality, Meritech has designed in the devices listed above to meet most jurisdictions. Conformity and compliance to local and national plumbing / health departments regulations regarding backflow prevention is the responsibility of the installer.

## Installing the EVO One

The CleanTech® EVO One connects easily to your existing hot and cold-water lines using standard ½" MNPT (faucet) style fittings. These fittings were chosen because they are commonly available, very reliable and can be disconnected quickly. You will also need a grounded 120V electrical outlet, and a standard 1 ½" drain line.

If these hook-ups are not readily available, you will need to consult with your commercial plumber or electrician. Because of the different building codes and licensing regulations, Meritech cannot accept responsibility for providing plumbing and electrical modifications to your facility. However, a Meritech installation specialist will be happy to provide the necessary guidance to ensure a correct installation.

Follow the instructions in the installation instructions below guide of this manual for further installation information.

## Installation Instructions

1. The facility will need to provide the appropriate facility utilities of hot & cold-water lines, drain, and electrical per the specifications in this manual.
2. Connect the drain line with a P-Trap or route drain line to a floor drain.
3. Connect Hot & Cold-Water line to the water inlets. Do not hard pipe to water inlets of the system – Use flexible hoses supplied with the system.
4. Plug in power cord to facility GFCI electrical outlet.
5. Install solution cartridges per the instructions within this manual or instructions on station.
6. Turn water on and inspect for leaks. Repair as necessary
7. Follow system onboarding instructions on touch screen.

# EVO One Cut Sheets & Installation Rough-In Diagrams

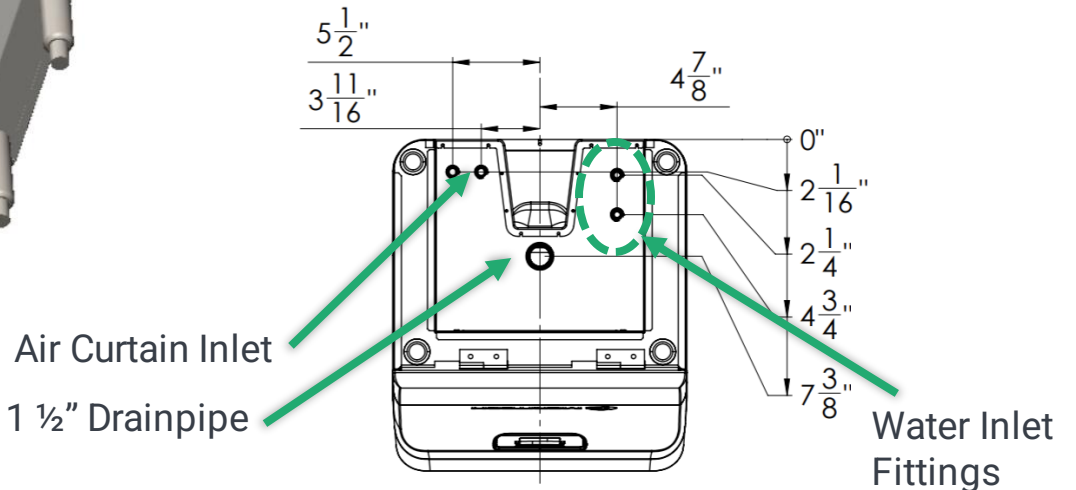
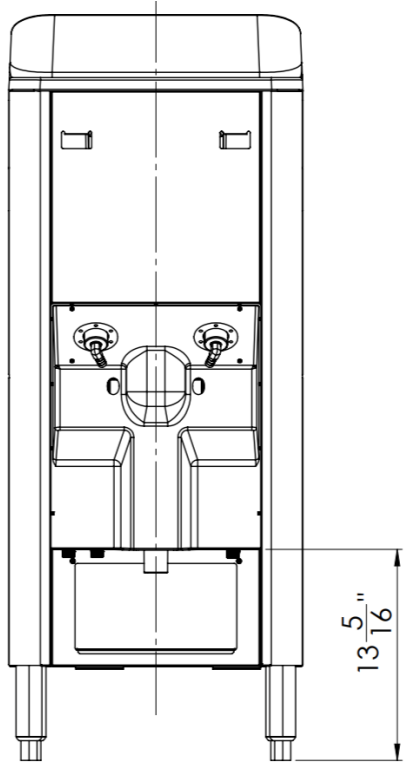
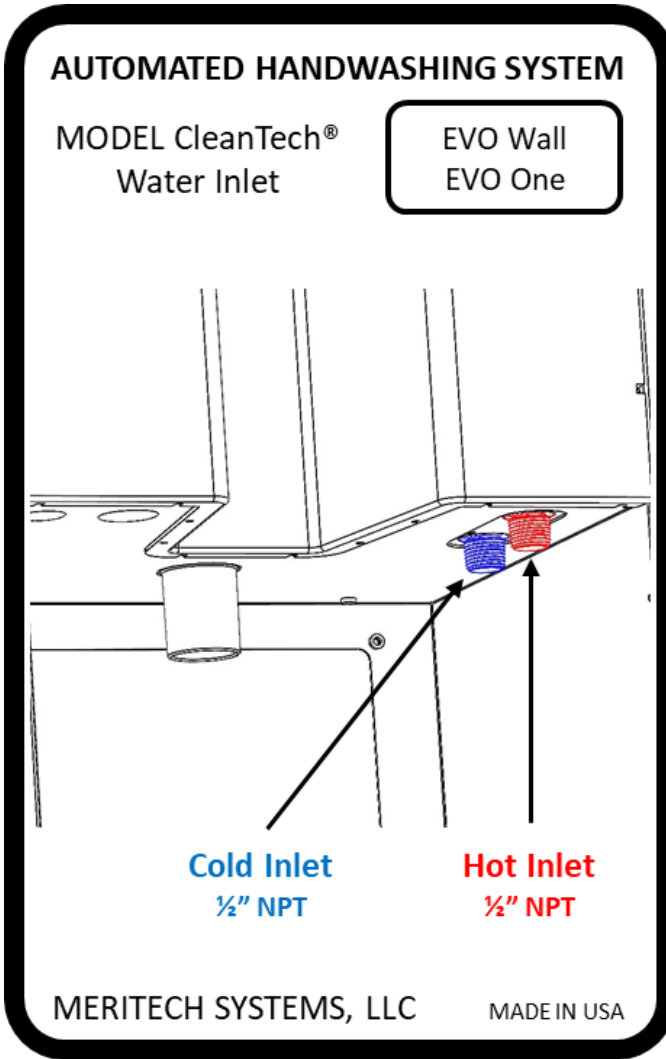

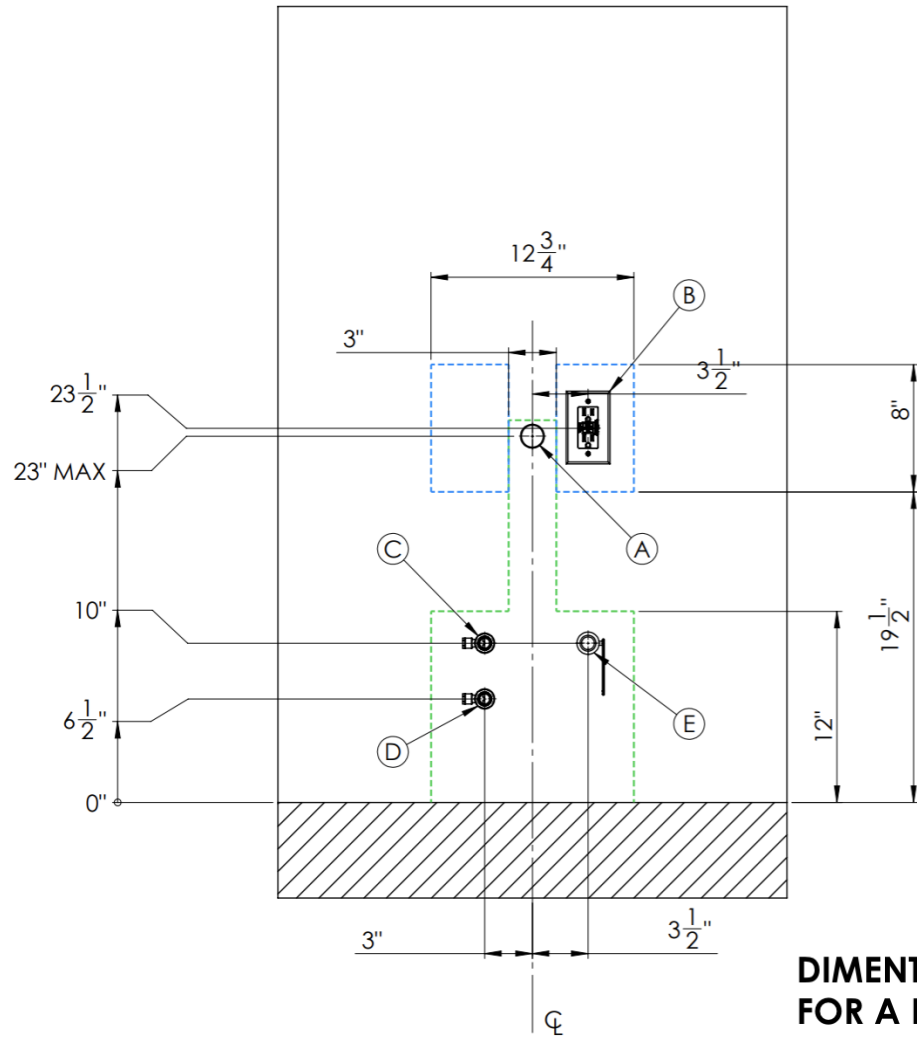

- A: WALL DRAIN STUB (1 1/2" WASTE)
- B: ELECTRICAL OUTLET (110 VAC, GFCI)
- C: COLD WATER INLET (SHUTOFF VALVE W/ 3/8" COMPRESSION MIN.)
- D: HOT WATER INLET (SHUTOFF VALVE W/ 3/8" COMPRESSION MIN.)
- E: AIR INLET; 19 CFM @ 25-30 PSI, 50 PSI MAX (1/2" BALL VALVE; PRESSURE REGULATOR SUPPLIED BY CUSTOMER)

**FACILITY LINE MUST BE AT LEAST 1/2" I.D. TO SUPPORT FLOW REQUIREMENTS**

**DIMENSIONS SHOWN ARE SUGGESTED LOCATIONS FOR A FLUSH TO WALL INSTALLATION: ALL WATER FACILITIES MUST LIE WITHIN THE DASHED, GREEN AREA; ELECTRICAL FACILITIES MAY LIE IN THE BLUE OR GREEN AREAS**

**IF YOU SHOULD EXPERIENCE ANY DIFFICULTY OR ARE UNSURE ABOUT THE INSTALLATION PROCEDURE, WE ENCOURAGE YOU TO CONSULT IMMEDIATELY WITH MERITECH.**

Meritech Systems, LLC  
720 Corporate Circle, Suite K  
Golden, CO 80401 USA

Website: [www.meritech.com](http://www.meritech.com)

Phone: (800) 932-7707

Fax: (303) 790-4859

E-mail: [support@meritech.com](mailto:support@meritech.com)

# Installing your CleanTech® Enhancements

## Installing the Sole Clean Sanitizing Pan Enhancement

1. Unpack the Enhancement for the EVO One per the instructions on the box.
2. Place the boot dip pan in front of the EVO One station, making sure that the pan is centered to the system and sitting level and does not rock. See drawing on page 17 of this manual.
3. Attach the supplied Sanifect D2 container basket to a wall that can support 70 lbs. vertical force.
4. Place Sanifect D2 bottle in basket and place pickup tube in bottle. Tube is attached to the system.
5. Place the three mats into the pan, ensuring that they are in the correct order from bottom to top:
  - Black bubble mat first
  - Grey absorptive mat (with soft side up) next
  - Red foot placement mat (with grip knobs upward) on top
6. Verify that the solution tubing is not kinked.
7. Press the unlock button on the touch screen and enter your customer pin number.
8. Once in the main menu, prime the pan by pressing the "Prime Pan" button shown in the photo. The pan will begin to fill, if additional fluid is desired, press the "Prime Pan" button again till the desire level is achieved.

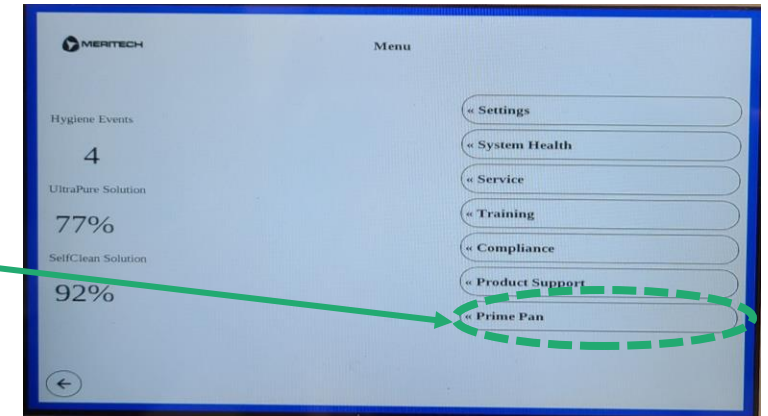
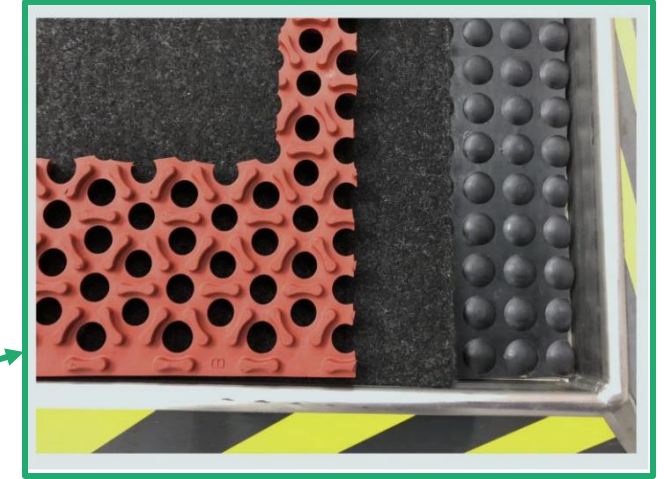



# Sole Clean Enhancement Cut Sheet

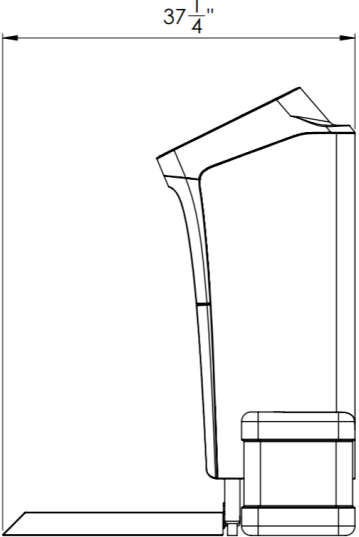
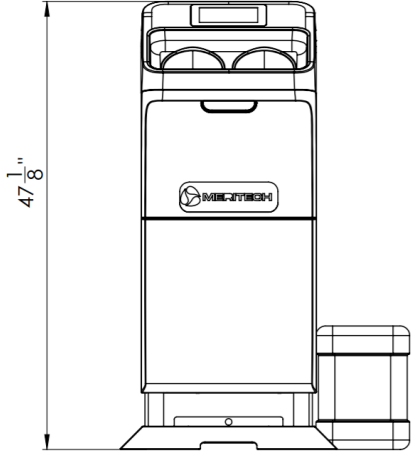
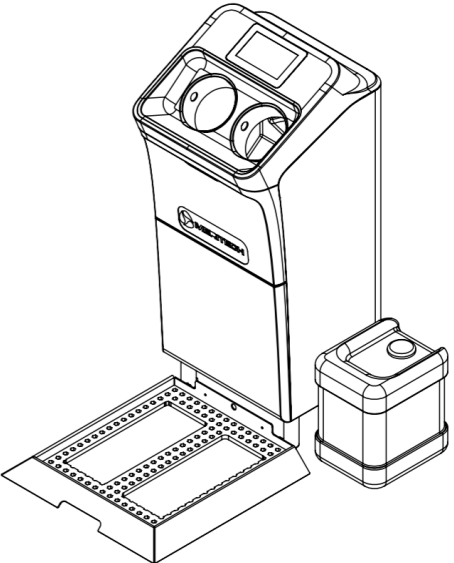
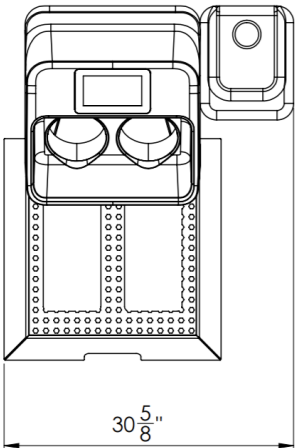

# Installing your CleanTech® Enhancements

## Installing the Wetted Boot Dip Pan Enhancement

1. Unpack the Enhancement for the EVO One per the instructions on the box.
2. Attached the two supplied clear hoses onto the fittings on the rear of the pan. These hoses push onto the fittings. **Do not hard pipe to these fittings for future cleanability and maintenance.** They are to divert the water from the pan to your required floor drain. If additional hose length is needed, contact Meritech Support Team.
3. Place the boot dip pan in front of the EVO One station, making sure that the pan is centered to the system and sitting level and does not rock. See drawing on page 19 of this manual.
4. Once the pan is in place, ensure the 2 drain hoses are directed towards the floor drain and that they are flat to prevent the pan from overflowing.
5. Press the unlock button on the touch screen and enter your customer pin number.
6. Once in the main menu, prime the pan by pressing the "Prime Pan" button shown in the photo. The pan will begin to fill, if additional fluid is desired, press the "Prime Pan" button again till the desire level is achieved.

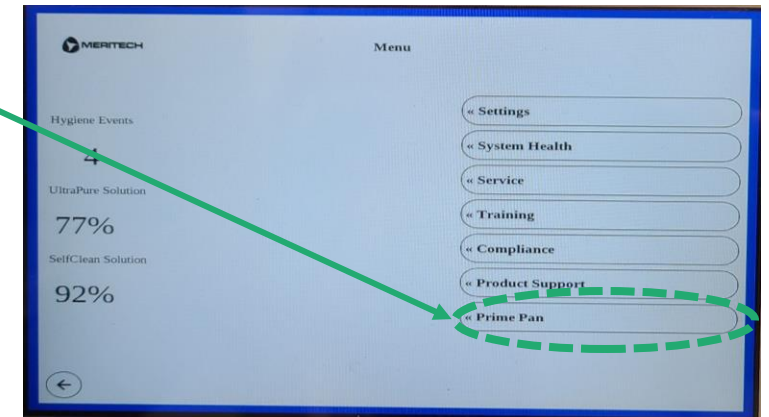

# Boot Dip Enhancement Cut Sheet

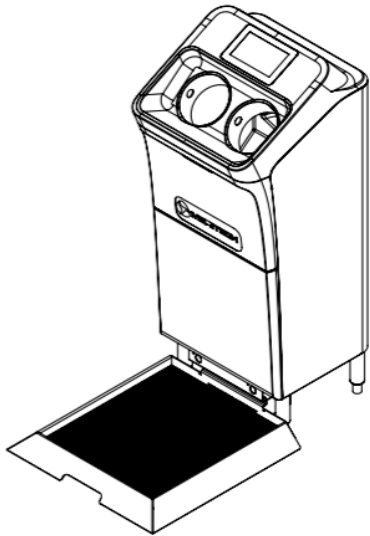
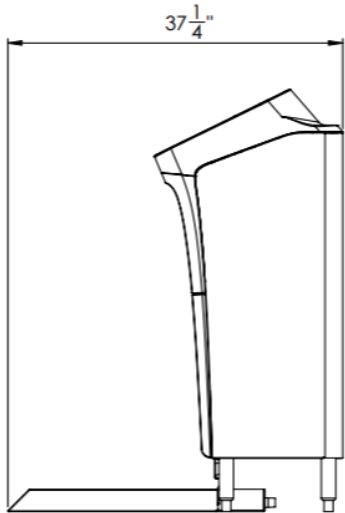
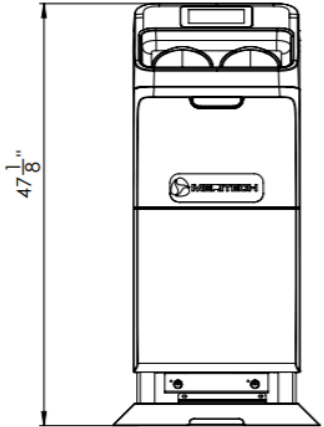
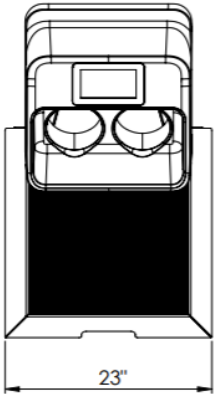

# Installing your CleanTech® Enhancements

## Installing the Controlled Access Turnstile

1. Unpack the Enhancement for the EVO One per the instructions on the box.
2. **Do not plug in the system or turnstile power cords until wiring is complete**
3. Complete instructions for the controlled access turnstile can be found in the manufacturer's manual [here](#) or by scanning the QR code. 
4. Assemble the handwasher/turnstile per the drawing on page 21 of this manual. This can be configured as either right or lefthand
5. While the top cover and front cover on the turnstile are removed for installation install the conduit into the right or left side of the turnstile
6. Run the power cord and control cable up the right or left/rear side of the turnstile. Secure in place with supplied tie wraps

Install the turnstile power cord wires per the photo (see right)

Black = Load    White = Neutral    Green = Ground with Yellow wire nut

7. Install the control cable to the control module  
Red= 24 VDC +    Black = I1 or I2 (see right)
8. Once wiring is complete, verify no AC or Control Cable wires interfere with moving parts of turnstile. Tie up wires with wire ties.



Turnstile information label

Turnstile control cable from the handwashing station

Turnstile power cord from the handwashing station

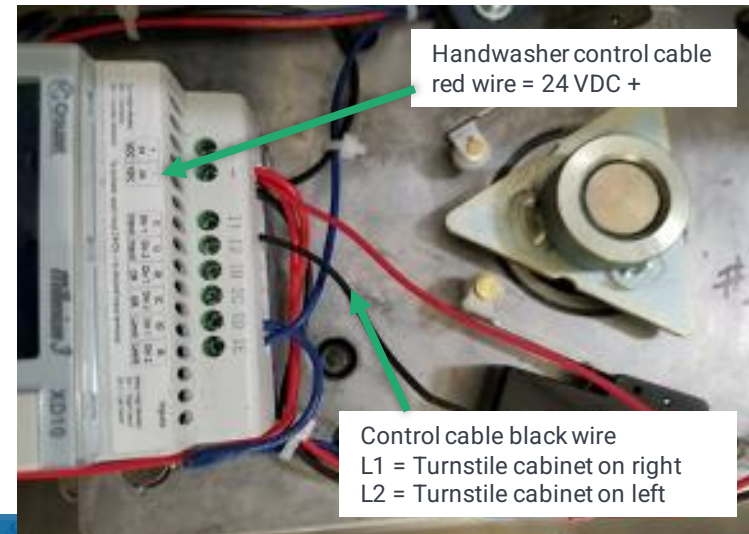

Handwasher control cable red wire = 24 VDC +

Control cable black wire  
L1 = Turnstile cabinet on right  
L2 = Turnstile cabinet on left

# Controlled Access Enhancement Cut Sheet

Please note: The Controlled Access Turnstile can be set up for right-hand or left-hand configuration.

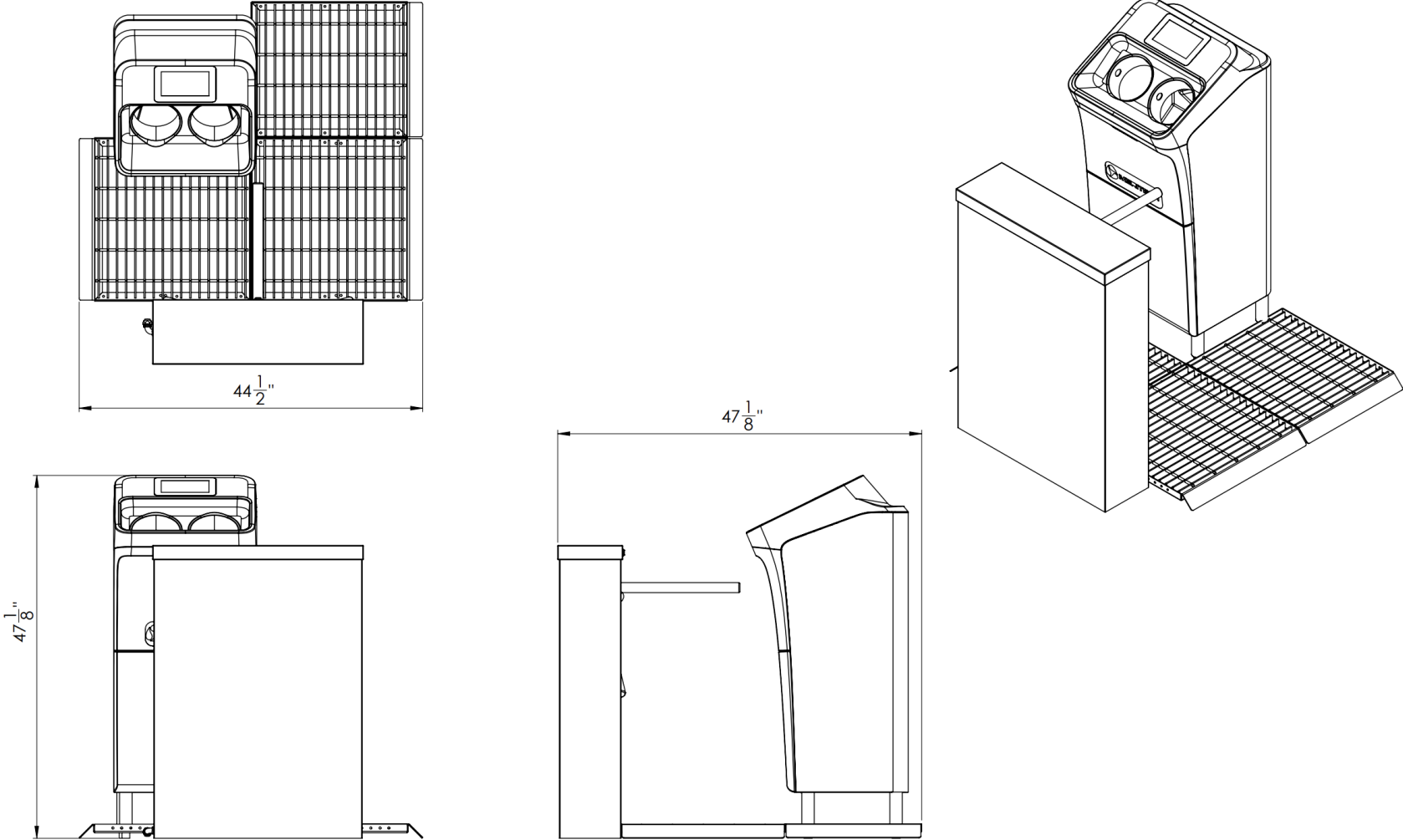

# Section 2

## Installing & Using Hygiene Solutions



## Importance of Using Meritech Hygiene Solutions

The CleanTech® EVO One system provides a no-touch, completely automatic hand wash by sequentially delivering handwashing solution and water in a stimulating spray to the hands or gloves from fingertips to wrist. The system uses the UP<sub>x</sub> UltraPure Hand Hygiene Solution and water to remove 99.9% and greater pathogens from the hands or gloves.

Our CleanTech® and UltraPure hand hygiene solutions were developed together to provide the perfect hand wash. We have over 50 independent clinical studies performed against a variety of harmful pathogens that can thrive on hands. We proved that when used with a CleanTech® Automated Handwashing Station, UltraPure provided a mean reduction of 99.9% of pathogens, including E. coli, Feline Calicivirus (a surrogate for Norovirus) and more. These efficacy studies proved unequivocally that CleanTech® with UltraPure results in greater pathogen reduction than a hand wash with any other type of soap. Download these efficacy studies and learn more at [www.Meritech.com/efficacy](http://www.Meritech.com/efficacy)

### Need to order more hygiene solutions?

Go the Digital Owner's Guide to order more solutions or contact the Meritech support team anytime at [support@Meritech.com](mailto:support@Meritech.com) or 1(800) 932-7707

**WARNING:** The performance and effectiveness of CleanTech® Automated Handwashing Stations have been extensively tested when using the hygiene solutions provided by Meritech Systems, LLC. Satisfactory performance or effectiveness of the CleanTech® Station cannot be guaranteed when other chemicals are used.

**FAILURE TO USE MERITECH SYSTEMS, LLC SUPPLIED CHEMICALS WILL VOID ANY AND ALL WARRANTIES**

# Installing Hygiene Solution Cartridges

## Unpacking and Installing the Meritech Hygiene Solution Cartridges

All CleanTech® EVO Automated Handwashing Stations require our hygiene solution cartridges to perform the perfect hand wash. To begin using your system, install the UPX UltraPure hand hygiene solution, using the instructions below:

**\*Please note the keyed fit for the solution cartridges, UP<sub>x</sub> will always be installed on the left while SelfClean<sub>x</sub> will be installed on the right.**

**Do not remove containers once installed**

### Hygiene Solution Replacement Instructions | Instrucciones para cambiar la solución higiénica

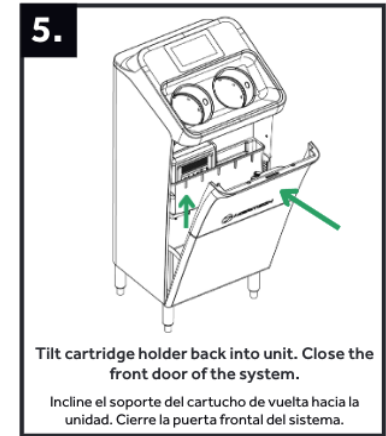
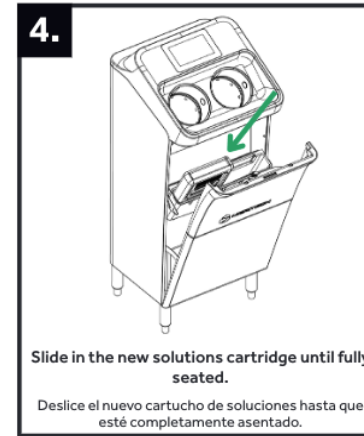
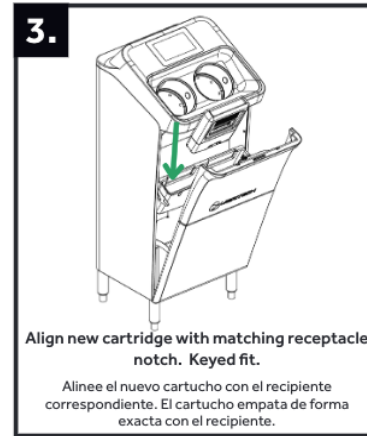
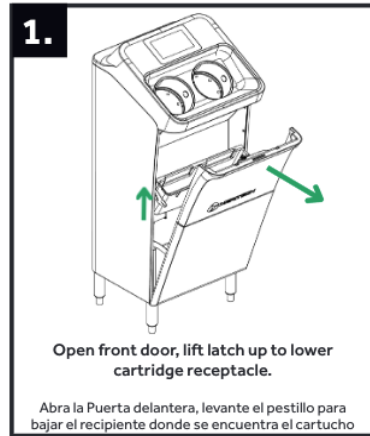

**CAUTION: UPX hand hygiene solution is installed on the left. To replace SelfCleanX, follow instructions above, but install on the right side.**  
**PRECAUCIÓN: La solución higiénica para manos UPX se instala a la izquierda. Para sustituir SelfCleanX, siga las instrucciones anteriores, pero instálo en el lado derecho.**

## Replacing and returning cartridges - **Don't throw away the empty cartridge!**

To reduce landfill waste and support sustainability efforts, all solution cartridges are designed to be recycled or reused. To recycle the cartridge, simply place within your recycling bins.

# Section 3

How to use the display touchscreen

## Station Setup Screens

The CleanTech® EVO station has been designed to be intuitive for users to both use and setup. Over this next section we'll dive into how the touchscreen display on an EVO station works during the setup process. **Please note: touch the screen with a firm touch, the screen was designed to be durable so it will not respond to a light touch.** For additional help using the display, please contact the Meritech support team at [support@meritech.com](mailto:support@meritech.com) or 1 (800) 932-7707.

### Welcome Screen

The initial welcome screen will begin walking you through setting up your CleanTech EVO Station.

This welcome screen will appear every time the system is powered on. If the station has been previously setup, use the "skip" button to bypass this process.

Press the "Setup" button to start the setup process





## Setting up the Wi-Fi connection:

Connecting the system to Wi-Fi will allow Meritech to monitor the health of the station and assist with trouble-shooting and updating software. Additionally, connecting to Wi-Fi will allow the compliance data that is generated from the system be available to you on the App (under development). No data is shared with any other source than Meritech and no personal information or identification is collected or shared.

If the "Yes" button is selected and you choose to connect the station to Wi-Fi, you will be guided through entering your Wi-Fi Network credentials.

If the "No" button is selected, please note that limited service and diagnostics may be limited. Additionally, time & date will have to be set manually, see page 31 to set the date and time in the system.

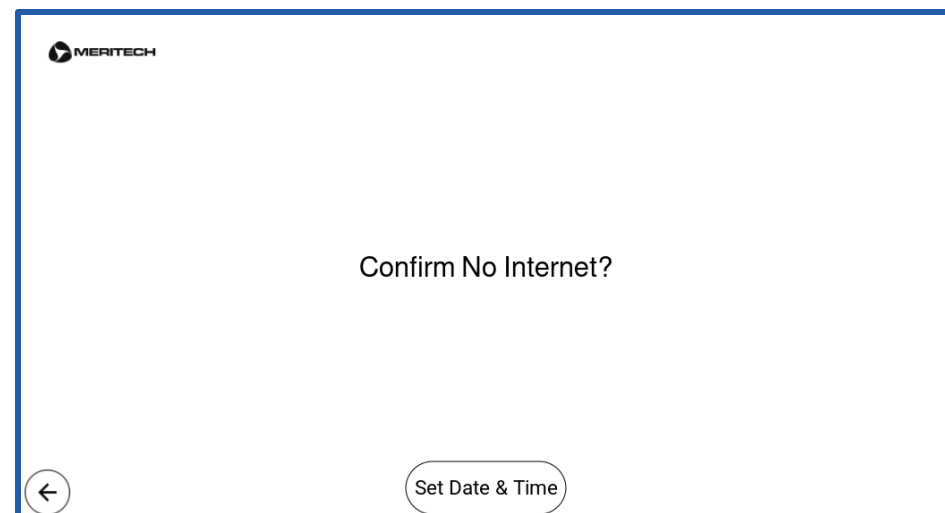
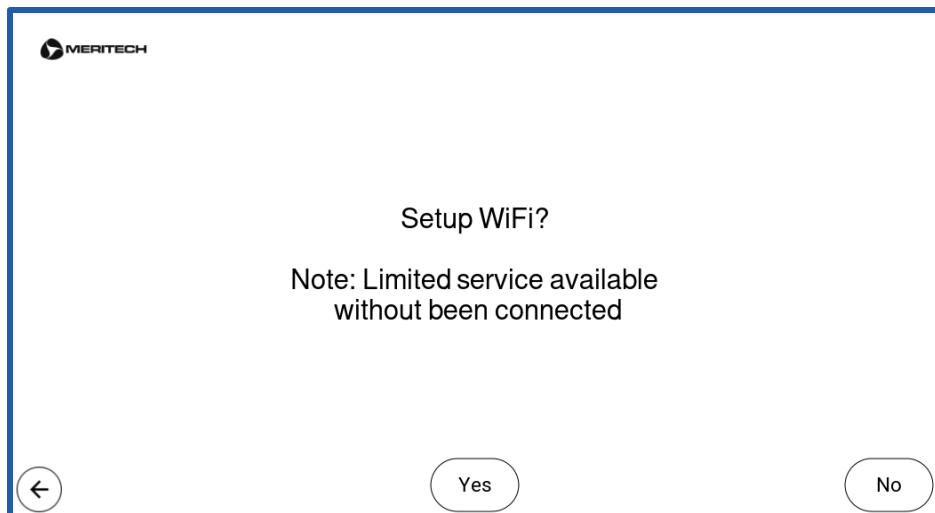

Unless written notice is provided otherwise by Customer to Meritech prior to the delivery of EVO system products, Customer agrees and authorizes the sharing and uploading to Meritech's or Meritech's affiliated servers from Internet-connect-capable EVO system products the following data: customer identification, unit serial number, manufacturing date, operational, troubleshooting, and maintenance data. The data will be used by Meritech to provide Customer maintenance and repair services. Data collected will not include any personal identifying information of specific users of the EVO system products.

## Configuring the Auto Warm Up Cycle schedule

Configuring the Auto Warm Up Cycle will allow you to customize the specific days and times that the handwashing station needs to be at the optimum temperatures of 100-105° F for your staff. Once set, the station will automatically turn on get the handwashing station to parameters set.

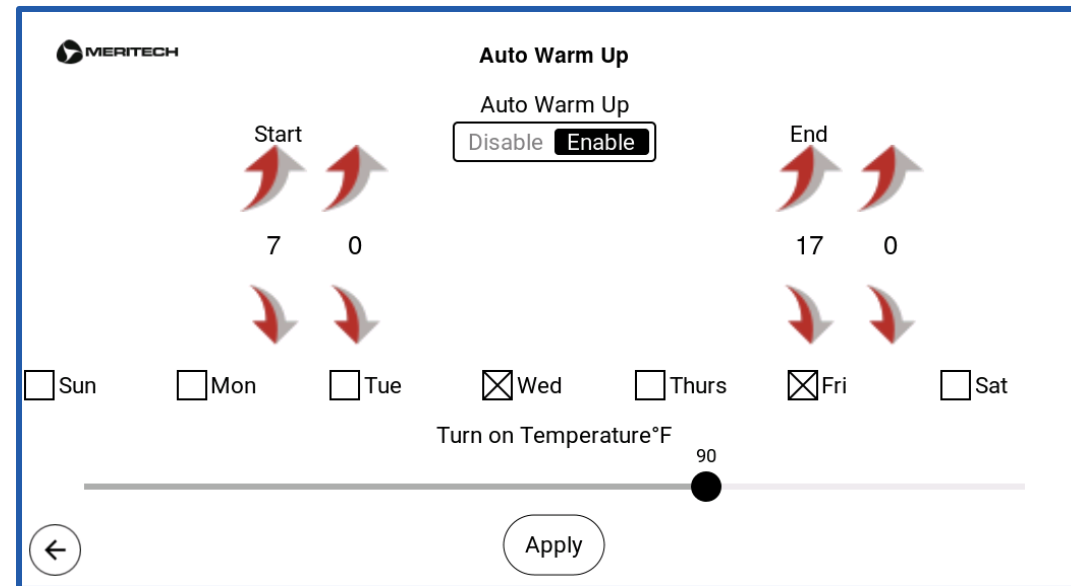
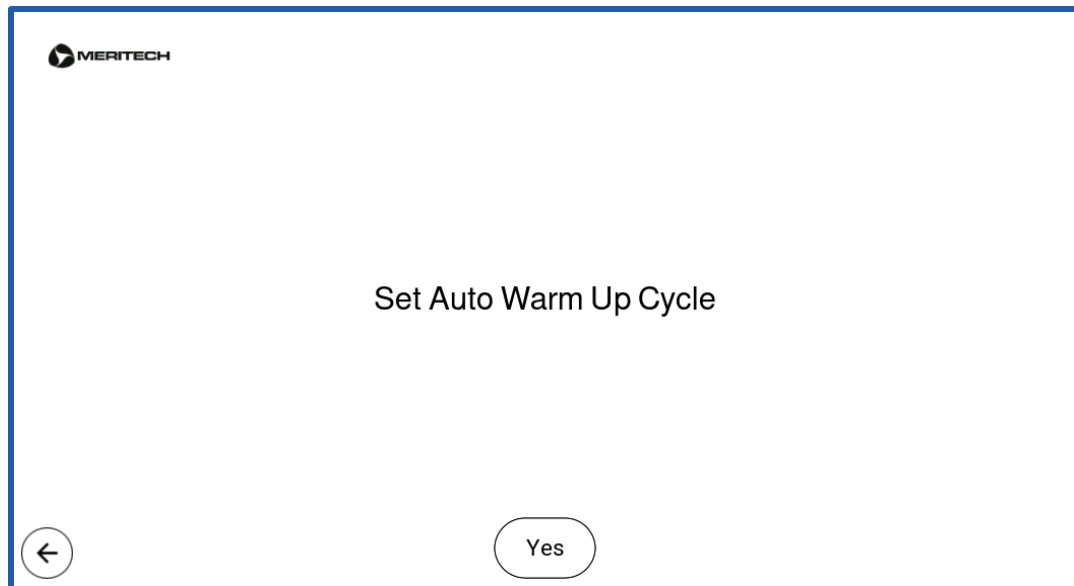

We recommend a water temperature range of 100– 105° F as it provides the most comfortable hand wash to promote the highest levels of handwashing compliance among your team. Temperatures that are too cold provide an uncomfortable handwashing experience and reduce compliance levels. The system will NEVER scald employee hands. We have several safeguards in place including an automatic shutdown should the water temperature reach above 110° F to prevent any injury to staff while using the station.

## Facility Drain and Water Connections

The next 3 screens walk you through verifying the facility drain, hot & cold lines are connected and turned on. For step-by-step instructions please see page 12 of this manual that review these install instructions.

Should you have any difficulty with these drain or water connections, please contact the Meritech support team.

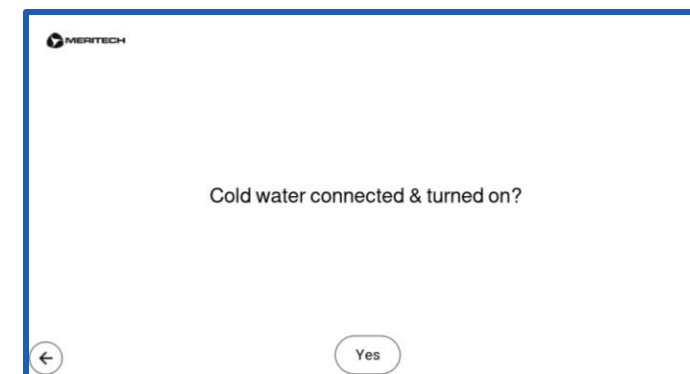
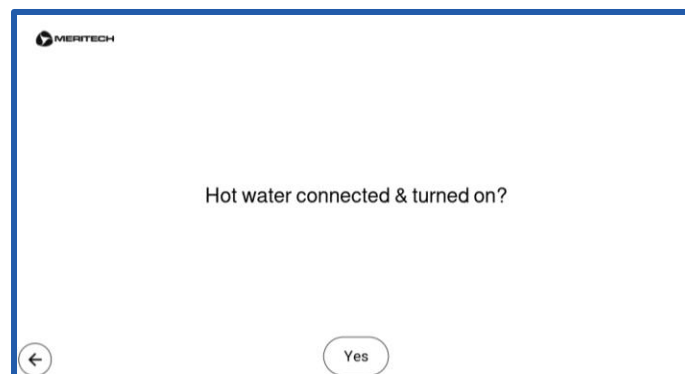
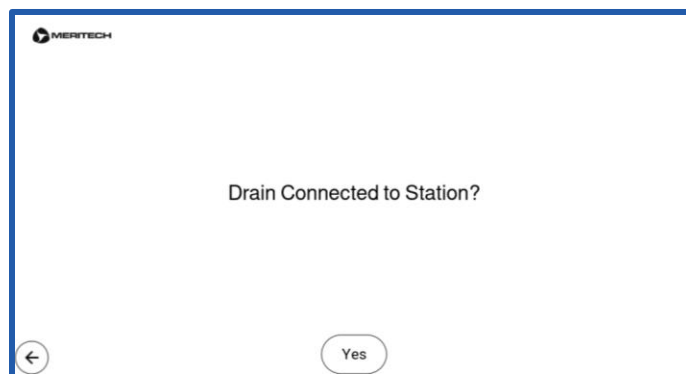

# Hygiene Solutions Installation & Setup

The next several pages will review the screens that will appear after the system installation screens. These next screens will walk you through the installing the hygiene solution cartridge(s) into your station.

## UP<sub>x</sub> UltraPure Solution Installation Steps

The screens shown to the right, will walk you through the steps to install the UP<sub>x</sub> UltraPure Hand Hygiene Solution cartridge in your station.

**The system will not run unless a UP<sub>x</sub> solution cartridge is installed into the station.**

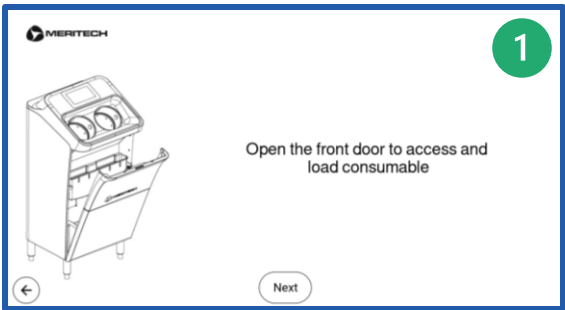

MERITECH 1

Open the front door to access and load consumable

Next



MERITECH 4

Slide open container guard exposing dispensing nozzle and RFID.

Do not remove the cap!

Next



MERITECH 2

Flip down the soap receptacle to load Self Cleaning soap container

Next

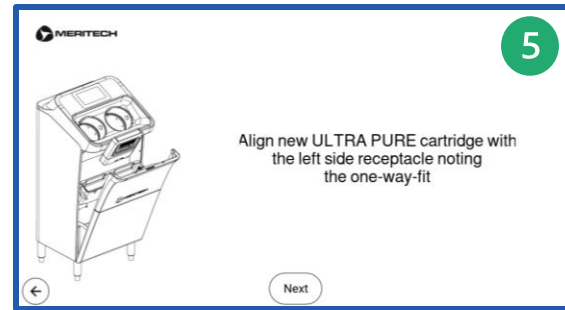

MERITECH 5

Align new ULTRA PURE cartridge with the left side receptacle noting the one-way-fit

Next



MERITECH 3

Prepare new Ultra Pure soap consumable

Next

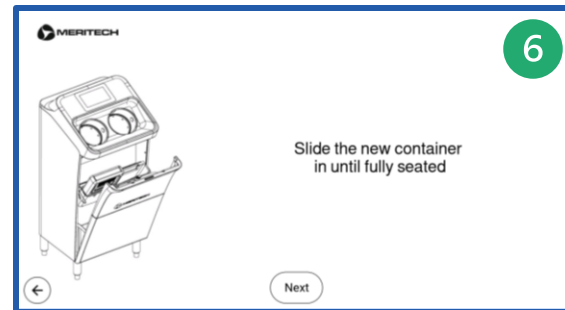

MERITECH 6

Slide the new container in until fully seated

Next

## SelfClean<sub>x</sub> Solution Installation Steps

The next several screens walk you through the steps of installation of the SelfCleanX – SelfClean hygiene solution cartridge in your station.

SelfClean may not be available on all models of CleanTech® EVO Stations. On the EVO One, the self-cleaning functionality of the station is a CleanTech® Enhancement. For additional information please contact the Meritech sales team at [support@meritech.com](mailto:support@meritech.com) or 1(800) 932-7707.

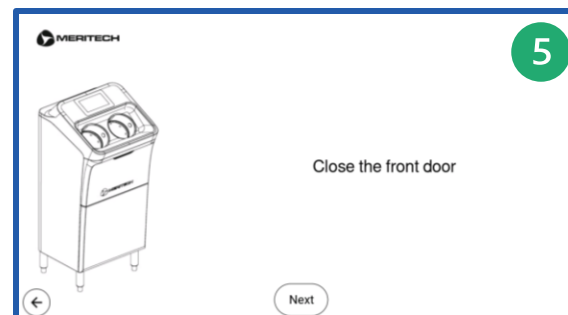
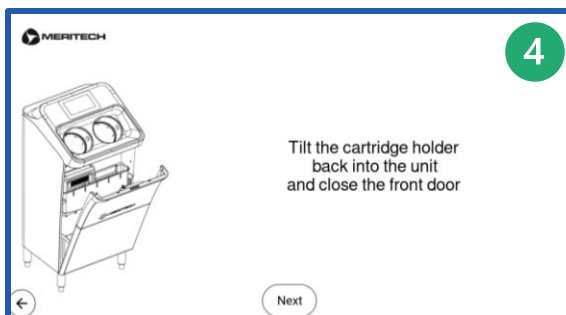
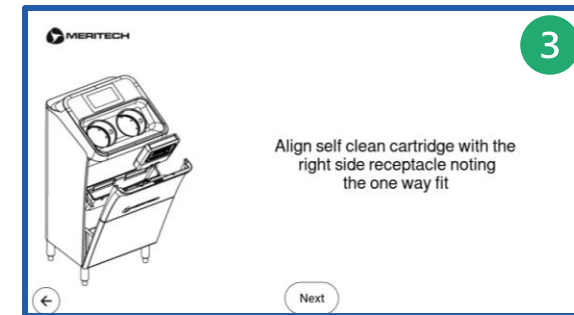

## Priming the CleanTech® Station

After the solutions have been installed, the system is now ready to be primed. Priming mode will fill the solutions lines with the UP<sub>x</sub> or SelfClean<sub>x</sub> solutions so that the very first handwash is prepared for the first user.

The next 3 steps prime the solutions in the solution and put the system in Run mode. The handwashing station is ready for use.

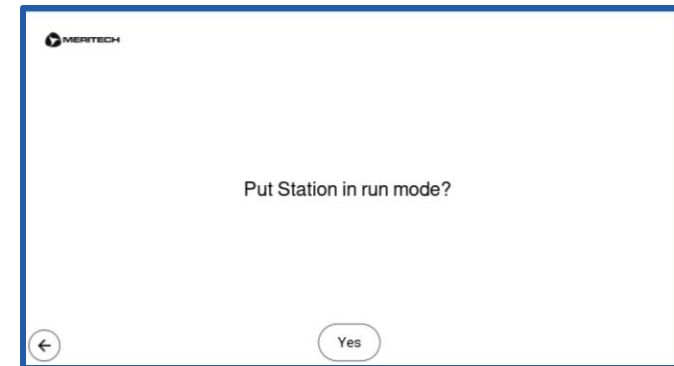
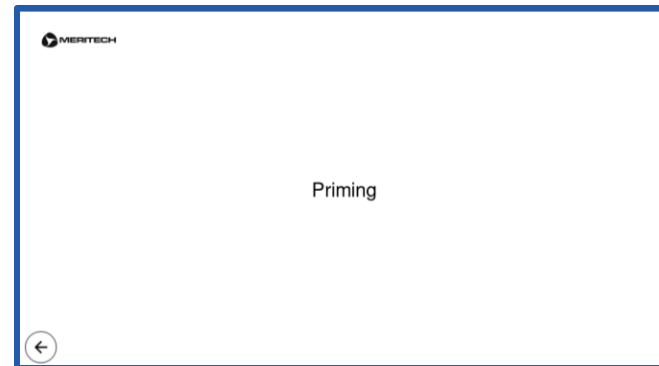

# Using the display touchscreen

The next several pages will review the displays that are accessible to you now that the CleanTech® station has been setup, configured and solution cartridges have been installed. These areas of the display can be accessed at any time now that the station has been setup.

## Navigating the Home Screen

The home screen will always show on the CleanTech® EVO station.

This screen will cycle through the handwashing instructions (shown on the next page) and will display key information including:

- Date and time (this can be configured in settings if not connected to Wi-Fi)
- Remaining hygiene events and hygiene solution levels for UltraPure and SelfClean (if applicable)
- Lock icon for quick access to the administrative area for additional settings.

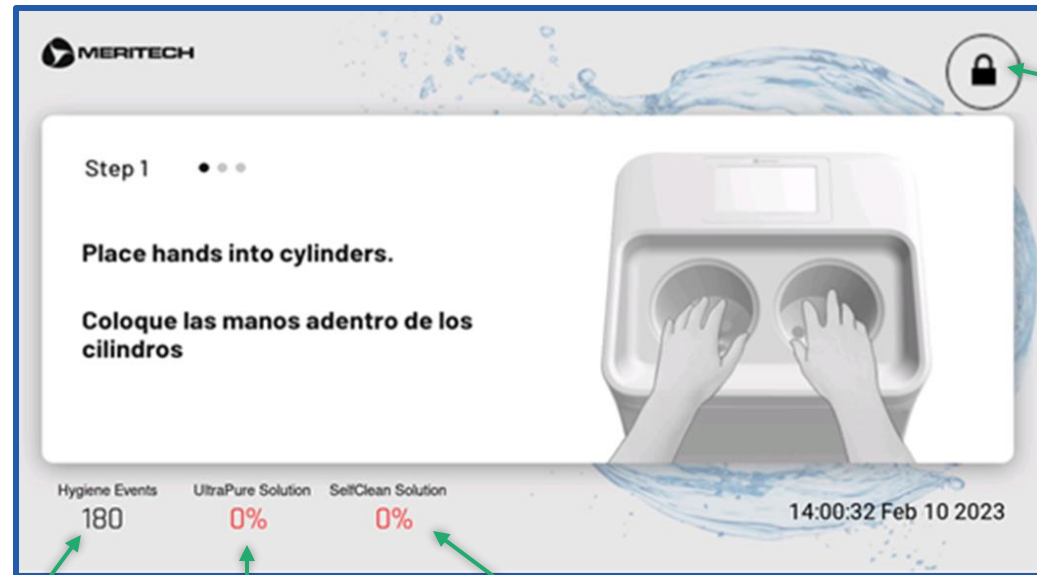

Unlock Screen for Main Admin Menu

Total Hygiene Events

% UltraPure Remaining

% SelfClean Remaining

## Handwashing Instructions

The steps on how to wash your hands with a CleanTech® Automated Handwashing Station are always cycling through on the screen for quick reference.

Hygiene tips will also show on the home screen communicating the importance of handwashing in preventing the spread of harmful pathogens.

These instructions and tips show in both English and Spanish. For help with additional languages, please contact the Meritech support team.





## Countdown Timer

During the automated hand wash, a countdown timer will display a large 12 second countdown timer. The purpose of this timer is to improve handwashing compliance and encourage users to keep their hands in the station for the full duration of the automated handwashing cycle.

Once hands have passed the photoeye sensor and initiated the hand washing cycle, the system will go into a 1 second priming mode to prime the cylinders with water. This is followed immediately by the 12 second automated hand wash cycle with rinsing, washing and final rinse.

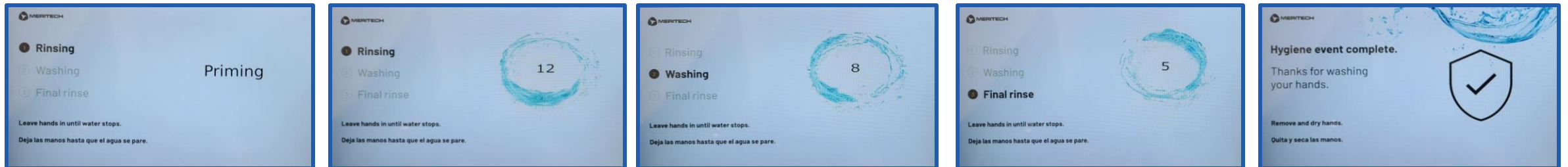

# Administrative Area of the Touchscreen Display

The next several pages will review the displays that are only accessible to administrators who are authorized with the pin to configure the station and view hygiene compliance information. These areas of the display can only be accessed with the customer pin.

## Customer Pin Check

Once You Touch the Lock Symbol  , on the home screen, the Customer PIN Check Screen Appears. Enter Last 4 Digits of Customer # and Press "E" to Access Main Menu

Enter Last 4 Digits of Customer # and press "E" (enter)

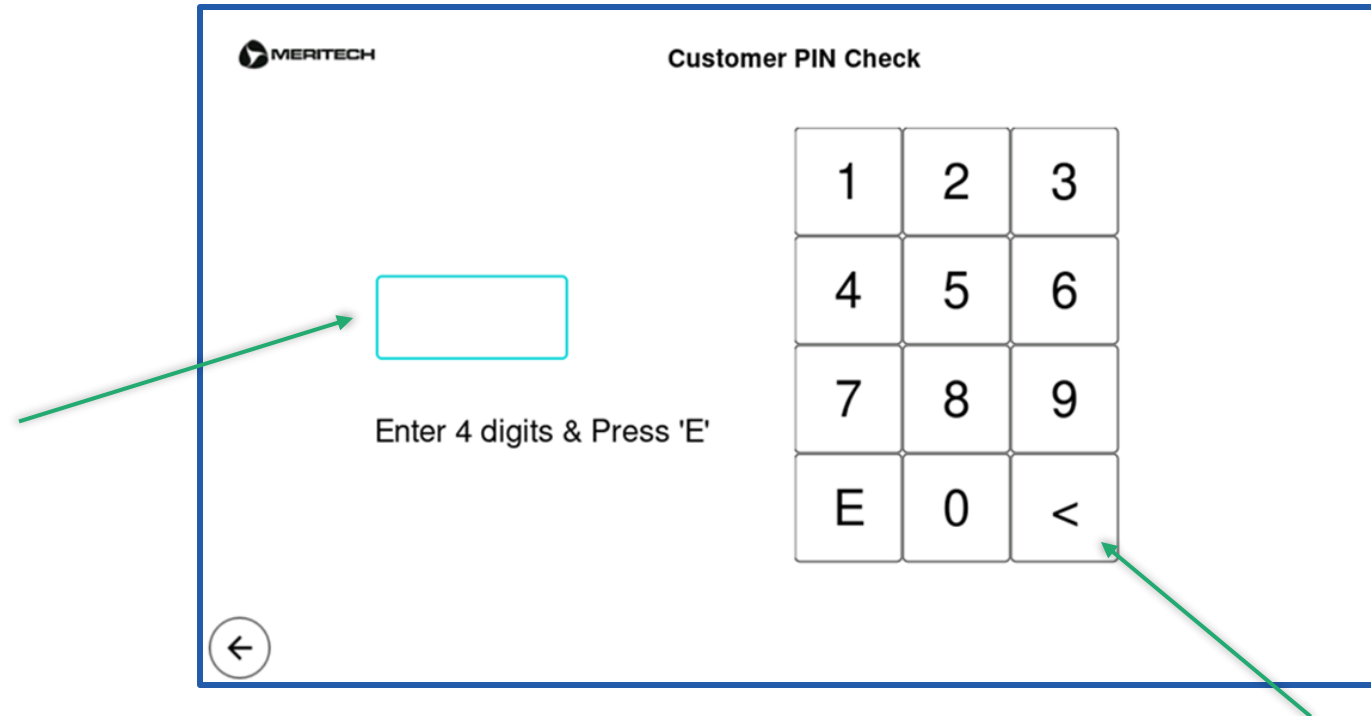

Return to Previous Menu

## Administrative Main Menu

Once in the Main Menu, you can select any of the sub-menus this will guide you to the specific area. These sub-menus area outlined within this manual as indicated in the table below.

Menus with a \* symbol are only accessible by Meritech Technicians

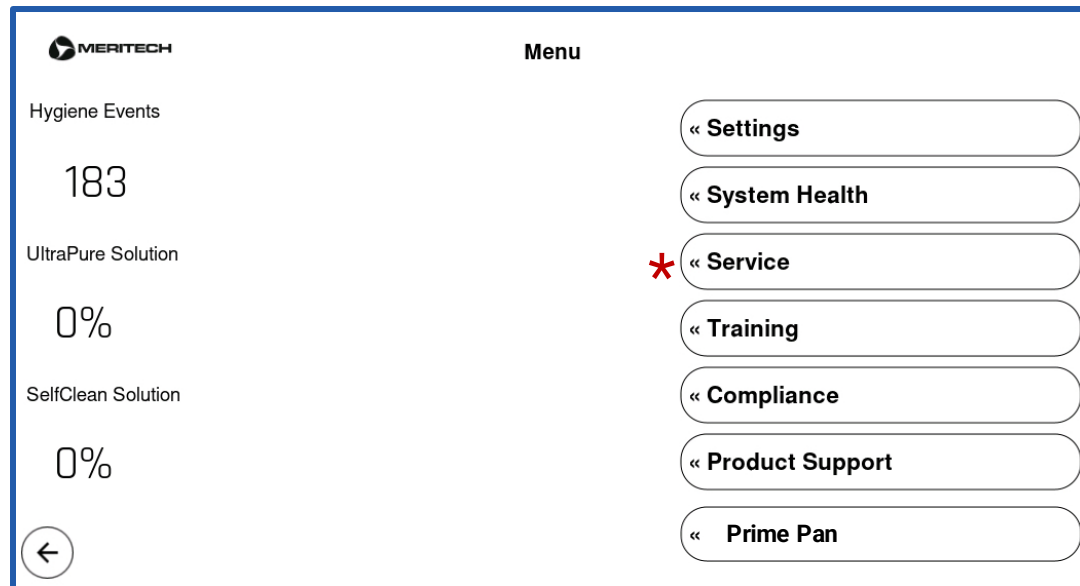

Menu Area	Pages in this manual
Settings	29 - 33
System Health	34
Training	35
Compliance	36
Product Support	37

## Admin Area - Settings

The next several pages of this manual will cover the system settings that are available to admins. The below system Settings screen allows you to adjust the network settings, units, date & time, water temperature, and language.

Menus with a \* symbol are only accessible by Meritech Technicians

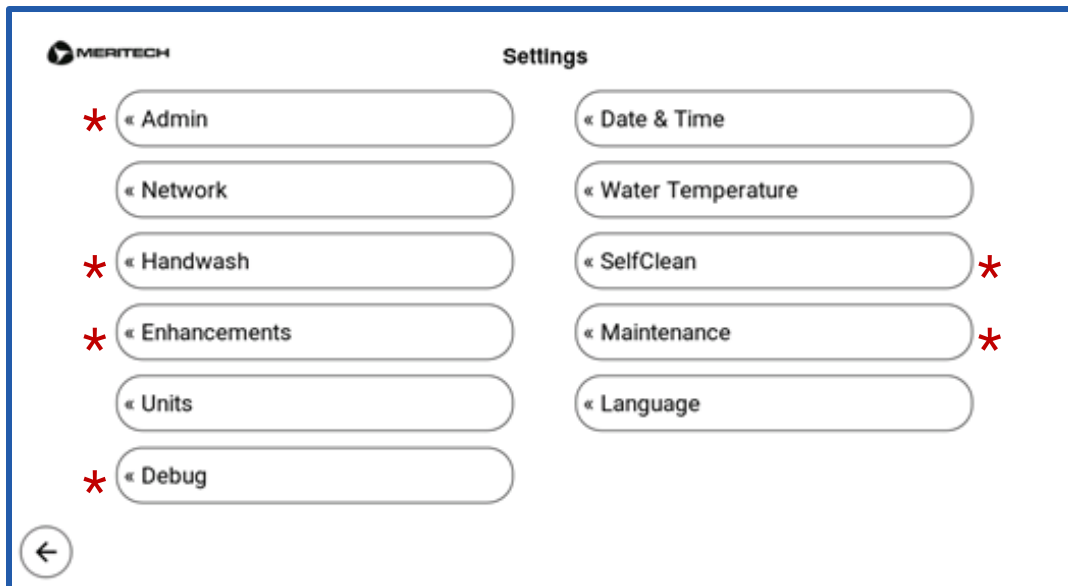
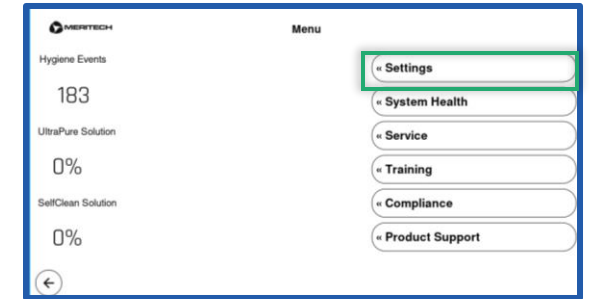

The Enhancements menu is accessible by Meritech technicians only. For configuration or adjustments to your CleanTech® Enhancements, please contact Meritech support at 1 (800) 932-7707

\* Menus only accessible by Meritech Technicians

# Admin Area Settings - Network

Network screens allow you to make edits to the Network connections

Network Status		
Parameter	Ethernet	WiFi
IP Address	xx.xx.xx.xx	10.0.0.46
Netmask	xx.xx.xx.xx	255.255.255.0
Flags	4099	4163
Status	UP	UP, RUNNING
Tx Packets	0	867
Tx Bytes	0	97116
Rx Packets	0	15546
Rx Bytes	0	3005402

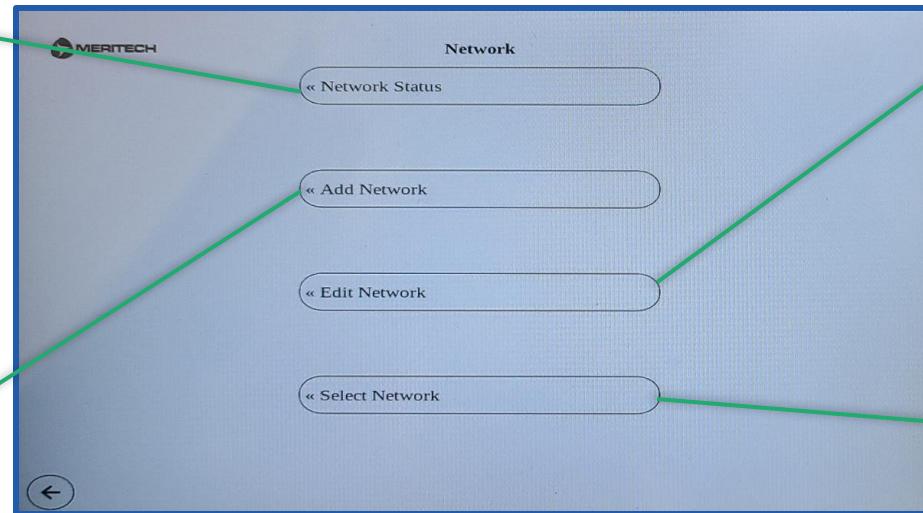

Edit Network

1: Meritech (\*)

Delete Network

SSID	BSSID	Freq	Sig	Flags
Meritech	d4-68-4d-30-0d-38	2437	100	[WPA-PSK-CCMF]
Meritech-Guest	d4-68-4d-70-0d-38	2437	96	[WPA-PSK-CCMF]
	0c-8d-d8-6f-d4-38	2462	68	[WPA2-EAP-CCM]
	32-8d-d8-6f-d4-38	2462	68	[WPA2-PSK-CCM]
Meritech	d4-68-4d-2f-e0-48	2412	64	[WPA-PSK-CCMF]
Meritech-Guest	d4-68-4d-6f-e0-48	2412	64	[WPA-PSK-CCMF]
nglHub_319444NDI	04-a1-51-5e-41-25	2462	60	[WPA2-PSK-CCM]
XHS-7A6EEFF6	02-cb-7a-6f-ef-fb	2437	48	[WPA2-PSK-CCM]
SuperTrampSecure	48-8f-5a-x8-19-9c	2442	48	[WPA2-PSK-CCM]
ECT-C6-HP	6e-02-e0-f3-a5	46		[WPA2-PSK-CCM]

Select Network

1: Meritech (\*)

Select Network

## Admin Area Settings - Units

Units' menu you allows you to switch from Imperial to Metric.

Note that a system restart will be required for the changes to take effect

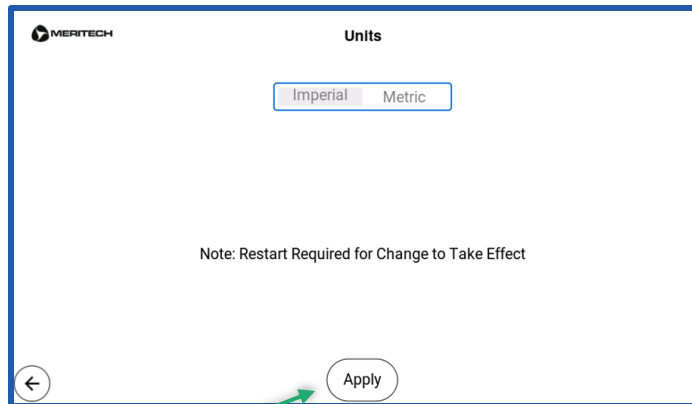

Once selection is made, always hit the "Apply" button to confirm selection

## Admin Area Settings - Time

If connected via Wi-Fi the Date & Time function will be automatic and will not need to be adjusted.

Only use this menu to adjust Date & Time manually if not connected to a Wi-Fi network

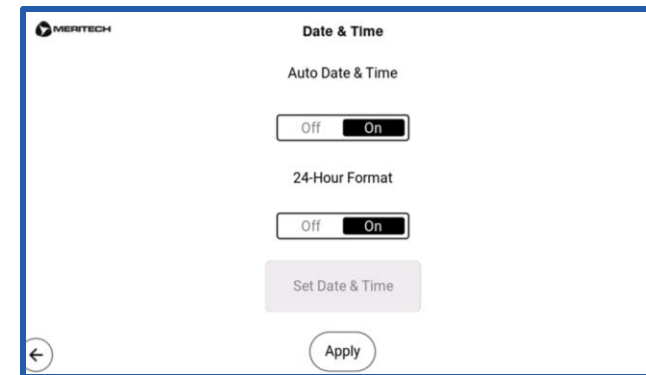

## Admin Area Settings – Water Temperature

The water temperature screen and its sub-menus allow adjustment to Auto Warm Up and Over Temp Shutdown

Menus with a \* symbol are only accessible by Meritech Technicians

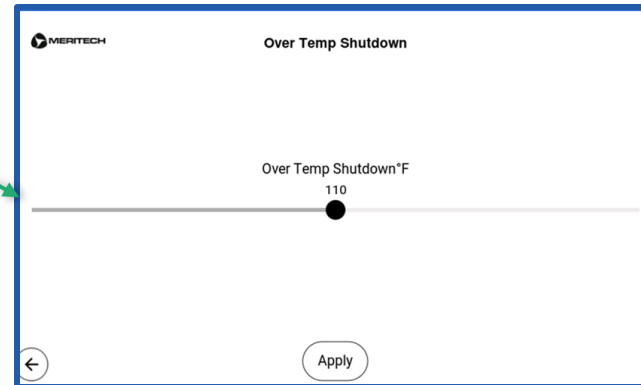
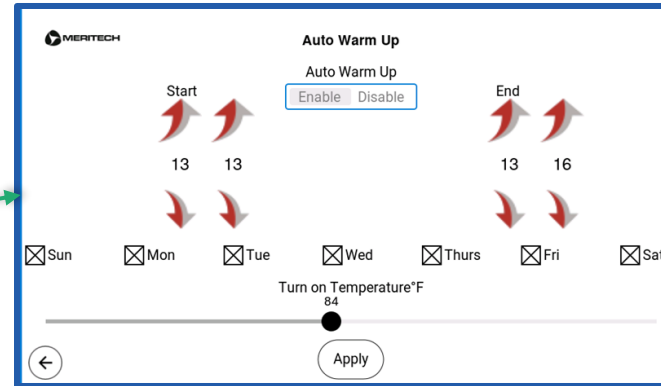
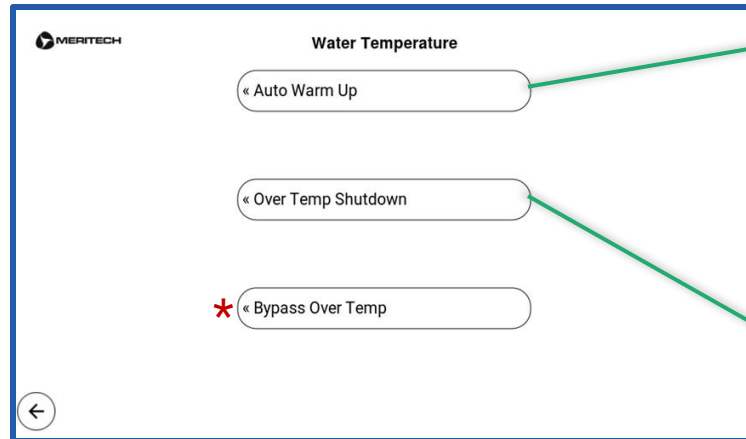

Menu used to adjust the Auto Warm Up cycle by Enabling and adjusting time and days per week. The station will maintain temperature during this timing

Though the CleanTech EVO system has a Thermostatic Mixing Valve, the station is equipped with an added Over Temp Shutdown feature. This Over Temp Shutdown will close the main water valve if water temperature exceeds this set point

## Admin Area Settings – Language

This screen allows you to set the language for the EVO Handwashing Station. Right now, only English is available, however other languages are being developed.

To change the language, click on the English bar above to then scroll through a list of languages and hit “Apply”.

**Restart of system will be needed for the change to take effect**

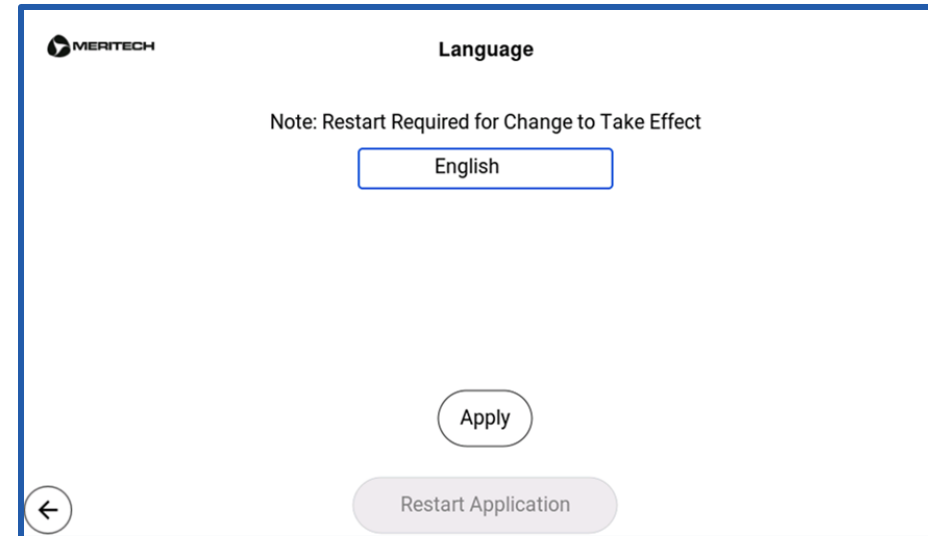



## System Health

System Health Screen Gives Real Time Data on the Health of the Facility and System as well as Current Solutions Levels, & any Error Codes

If one of these settings is out of parameter a station error code will be displayed.

Some of these items might self-correct in time. For instance, if the facility hot temperature is too cold, and if hot water returns to normal temperature range, the code will clear.

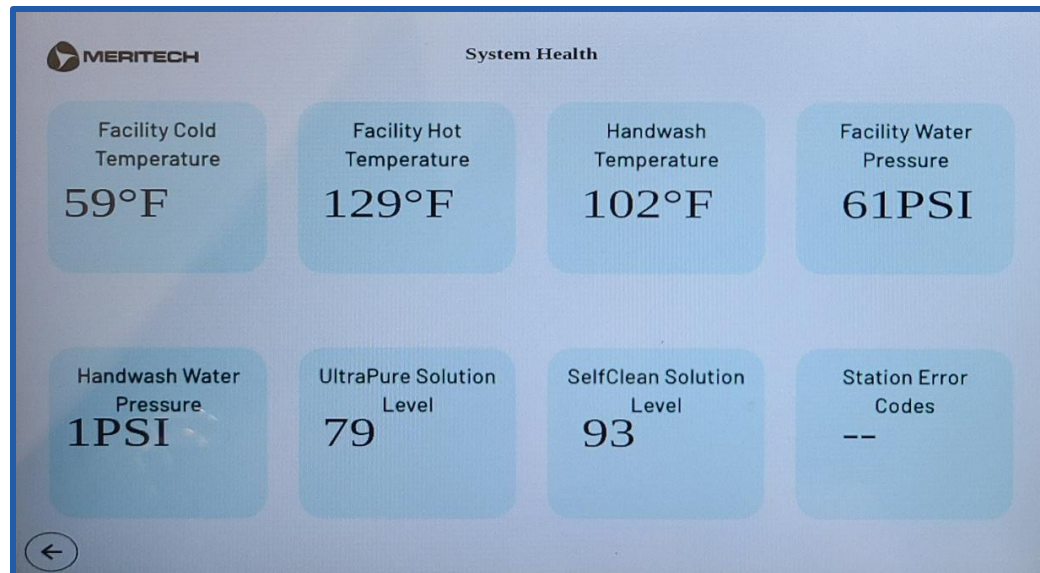
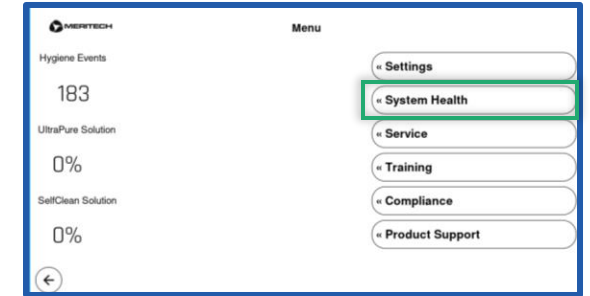

## Training

The Training menu you allows you an easy way to onboard new staff members on how to use the station by watching a video.

The EVO station also has a video on how to change solutions for your maintenance team.

There are also QR codes under Owners Guide and Meritech Website that will guide you to many documents to help with all your hygiene needs

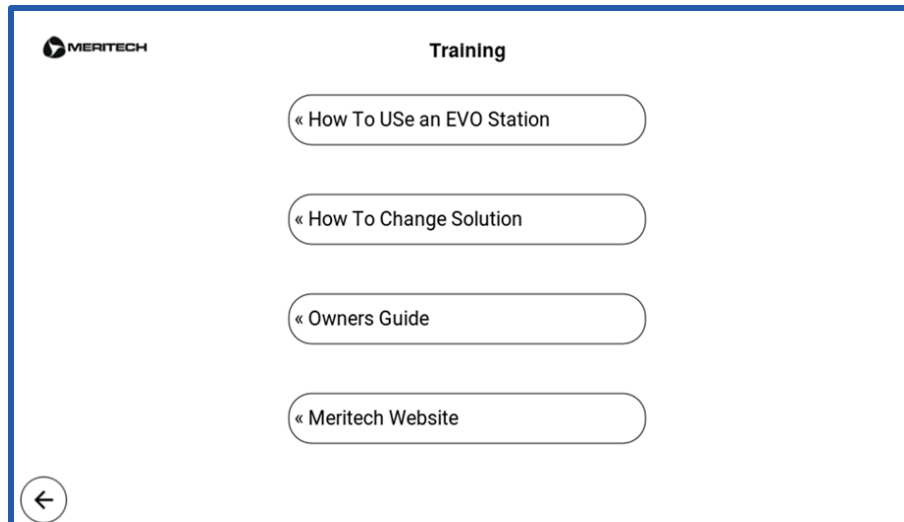
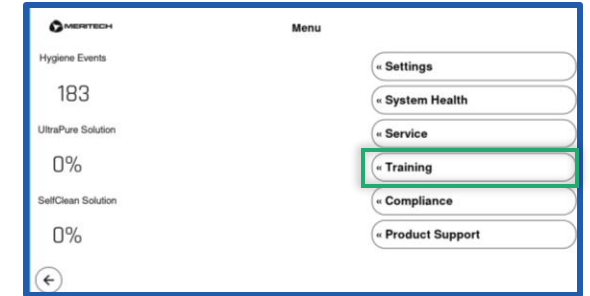

# Compliance

Within the Compliance menu you will be able to perform a few functions

Enable or Disable the Auto Count Rest. Auto Count Reset allows for a time of day you chose for the Hygiene Events in the Home screen to be reset to zero. When feature is Enabled, the standard time is 2 AM. This reset does not clear the Historical Hygiene Event log or master counter for the station

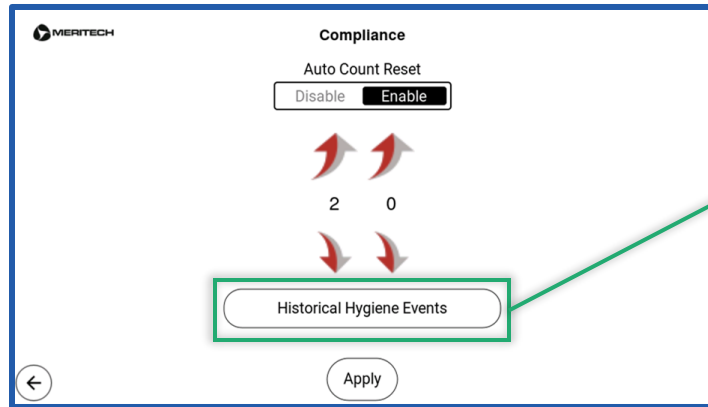
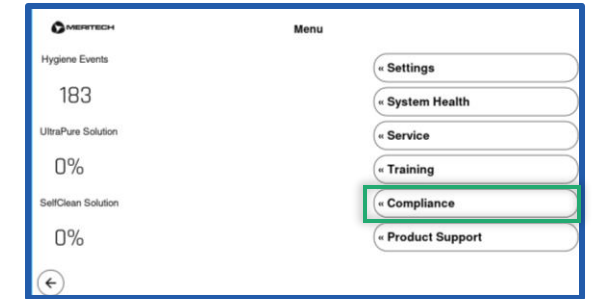

## Historical Hygiene Events

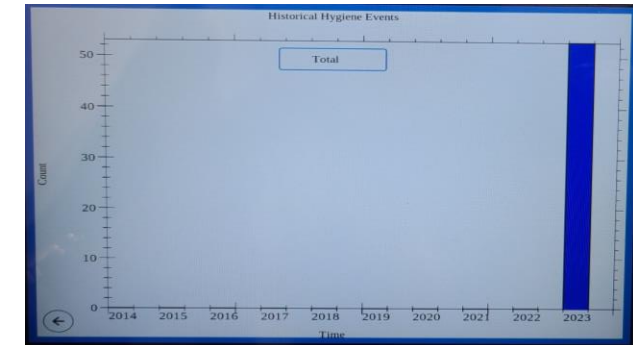
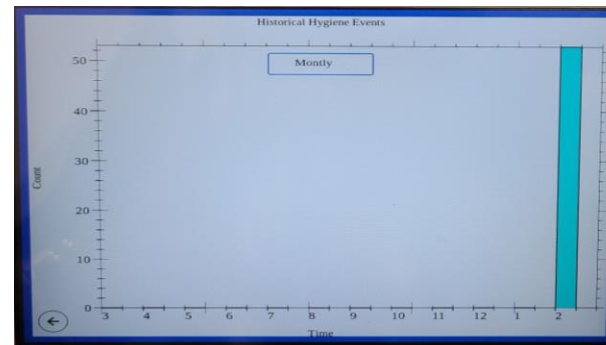
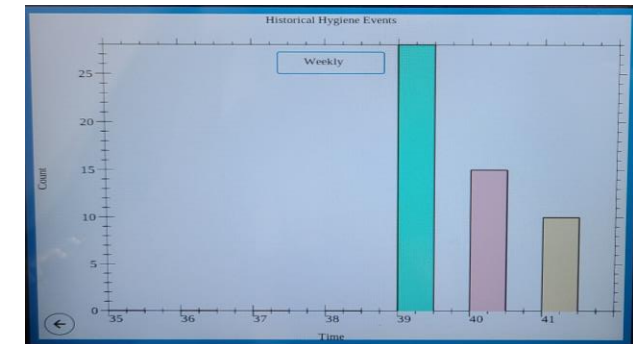
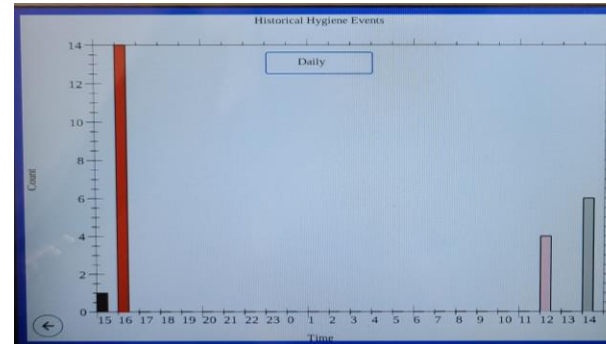

When the Historical Hygiene Events button is pressed, you can see histogram graph of the hygiene events for each EVO handwashing station.

When you click on the word "daily" there is a dropdown menu allowing you to see the data in several configurations to meet your needs including daily, weekly, monthly and total.

## Product Support

The Product Support screen displays the system model, system serial number, manufactured date, software revision level, customer ID, customer pin #, last service date, & last calibration date

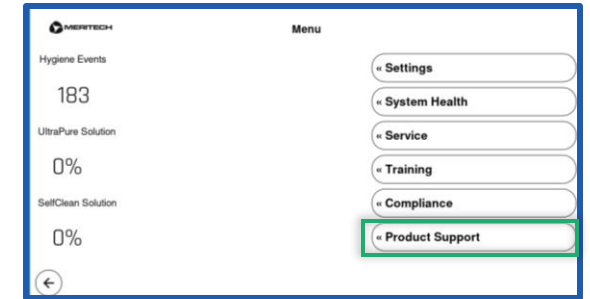
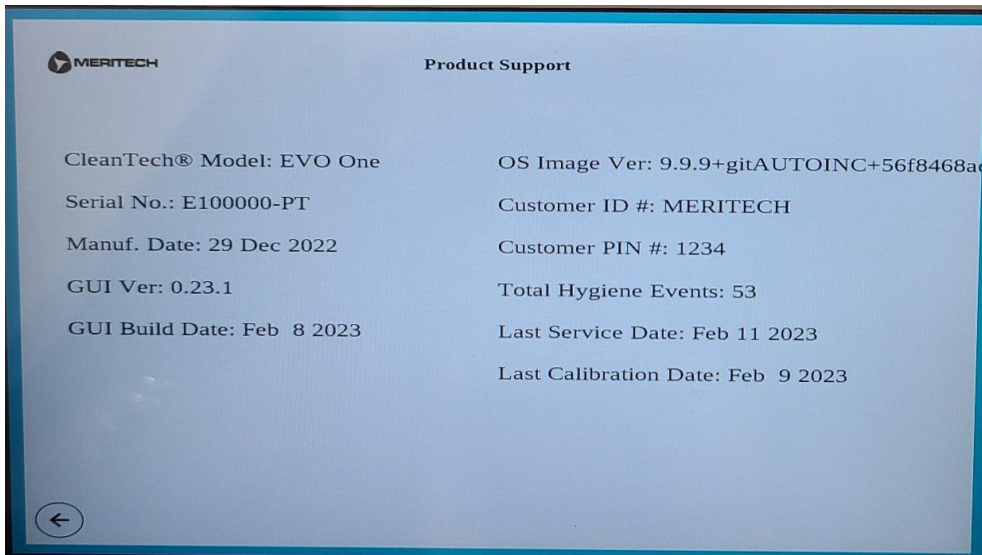

### Calibration

This station has already been calibrated to ensure maximum performance.

For calibration information see the CleanTech station's "Product Support" screen or reach out to the Meritech support team.

# Section 4

## Maintenance & Components of this EVO Station

### Protect Your Station

Meritech does not recommend hose down or power washing any CleanTech® EVO stations.

**Hand Wipe Only**

## Cleaning & Maintenance Instructions for this EVO Station

To maintain your EVO stations cleanliness and high-quality handwashing that is expected from a CleanTech® station. We recommend following the cleaning schedule below for the system. **Please note: cleaning instructions for the touchscreen display are on the next page.**

### Daily Cleaning/Disinfecting:

- Hand wipe external surfaces using a clean, dry non-abrasive cloth to remove dirt or smudges gently. We recommend a Microfiber cleaning cloth.
- If further cleaning is needed, use a commercially available product such as glass cleaner or multi-surface cleaner. Dampen a clean, dry non-abrasive cloth or use a pre-moistened wipe that is non-abrasive.
- Allow surface to dry.
- Followed by disinfecting per the steps outlined on Page 39 of this manual.

### Weekly:

- Pour, rub, or spray a bleach, ammonium chloride, hydrogen peroxide, or other hard surface disinfectant into each cylinder to kill any residual pathogens that may be in the system or facility drain. Always follow manufacturer's instructions on cleaning solutions.
- Clean cylinder surfaces with a cleaning agent that removes mineral deposits. You may use a cleaning brush to assist with cleaning cylinders. Contact Meritech to get a cylinder cleaning brush.

### Quarterly:

- Clean photoeye lens with a clean, dry non-abrasive cloth to remove dirt or smudges gently. We recommend a Microfiber cleaning cloth.

### As Needed:

- Replace cylinder every 30K – 50K handwashes or when mineral deposits buildup or water spray pattern or splashout becomes excessive. This service can be performed by a Meritech Technician.

Cleaning and disinfection are two different steps. Cleaning refers to removing pathogens, dirt, & impurities from surfaces. Disinfecting refers to using chemicals to kill pathogens on surfaces. Refer to acceptable disinfecting solutions on page 39 of this manual.

## Touch Screen Cleaning & Disinfection

When cleaning a touchscreen, it is important to realize they are sensitive to chemicals and high pressure washdown. They are also subjected to scratching if cleaning with abrasive cloths that will then affect the operation of the touchscreen.

Cleaning and disinfection are two different steps. Cleaning refers to removing pathogens, dirt, & impurities from surfaces. Disinfecting refers to using chemicals to kill pathogens on surfaces.

### To Clean:

- Use a clean, dry non-abrasive cloth to remove dirt or smudges gently. We recommend a Microfiber cleaning cloth.
- If further cleaning is needed, use a commercially available product such as glass cleaner to dampen a clean, dry non-abrasive cloth or use a pre-moistened wipe designed for cleaning electronics.
- Allow surface to dry.

### To Disinfect:

- Dampen a new clean, non-abrasive cloth with a disinfectant from the list below. Ensure excess liquid is squeezed from the cloth. You may also use pre-dampened wipes if they are non-abrasive.
  - Household bleach solution (1/3 cup per gallon water)
  - Isopropyl Alcohol (< 71% alcohol)
  - Clorox Disinfecting Wipes
  - Read the manufacturer's instructions carefully. Many require surface to remain wet for a period of time to be effective.
  - Allow surface to dry.

**Note: Resistive touch screens can be damaged by overly aggressive cleaning or impact. Hand clean display only.**

Clorox® is a registered trademark of The Clorox Company, Oakland California. Copyright The Clorox Company

## Sole Clean Pan Enhancement Maintenance

The frequency and type of cleaning will depend on the environment that the system enhancement is installed in, the frequency of use and the quantity of debris being removed from the footwear. The cleaning process should also be documented within your HAACP or SSOP procedures and/or your company's internal procedures.

### **Meritech recommends daily cleaning of the sole clean pan.**

Follow the same process below for the controlled access turnstile enhancement with the sole clean pan.

1. Pull pan forward away from the EVO Station.
2. Remove excess fluid from the pan. Fluid may be dumped down a sanitary sewer line or dump sink.
3. Remove the three mats from the pan and hose down/scrub the pan to remove soils and debris.
4. Hose down/scrub the entire inside, top, bottom and sides of the pan to remove soils and debris.
5. Hose down/scrub the rubber mats to remove soils and debris.
6. Inspect the Felt mat for wear and tear. If worn, replace the Felt mat. If cleanable, brush soils and debris from mat using stiff brush.
7. Sanitize all pan surfaces and following sanitizer chemical instructions per manufacturer's instructions.
8. Inspect the safety tape on the pans and replace, as necessary.
9. Once the cleaning procedure has been completed per the instructions above, re-assemble the pan per the instructions in this manual on page 16
10. Re-prime the pan per the instructions on page 16 of this manual.



## Boot Dip Pan Enhancement Maintenance

The frequency and type of cleaning will depend on the environment that the system enhancement is installed in, the frequency of use and the quantity of debris being removed from the boots. The cleaning process should also be documented within your HAACP or SSOP procedures and/or your company's internal procedures.

### **Meritech recommends daily cleaning of the wetted boot dip pan.**

Follow the same process below for the controlled access turnstile enhancement with the boot dip pan.

1. Carefully and slowly lift the boot dip pan to drain the water from the pan. Hold the pan up a 30° angle for approximately 15-30 seconds. 
2. Once drained, pull the pan forward away from the CleanTech EVO Station.
3. Disconnect the 2 drain diverter hoses from the back of the pan(s), pans can now be removed from the system and cleaned.
4. Remove the mat from the boot dip pan and hose down/scrub to remove any soils and debris
5. Hose down/scrub the entire inside, top, bottom, sides and pan drain to remove soils and debris. Depending on the soils encountered in the facility, degreasers or other chemicals may be necessary to be used on the pan to keep it clean and to remove or prevent biofilms. Always follow chemical manufacturers instructions.
6. Sanitize all pan surfaces and following sanitizer chemical instructions per manufacturers instructions.
7. Inspect the safety tape on the pans and replace, as necessary.
8. Once the cleaning procedure has been completed per the instructions above, re-assemble the pan per the instructions on page 18 of this manual. (Rubber mats can expand in time, either cut mat further down to fit pan snugly or contact Meritech Support Team to order a new mat)
9. Re-prime the pan per the instructions on page 18 of this manual





# Major Components of this EVO Station

## External Components



## Internal Components

Bottle Pierce Tube  
Assy. (internal to solution receptacle)  
– UPX & SelfCleanX

Solutions Bottle Vent Check Valve  
(back side of receptacle)

Solutions Receptacle

Solutions Receptacle  
– PCB Assy. UPX

Top Cover Screws  
(solutions door must be  
opened to access screws for  
top cover removal)

Station Serial Label

Solutions Bottle Vent Check Valve  
(back side of receptacle)

Solutions Receptacle  
Tilting Latch (both sides)

Solutions Receptacle  
– PCB Assy.  
SelfCleanX

Plumbing Access  
Panel



# Internal Components

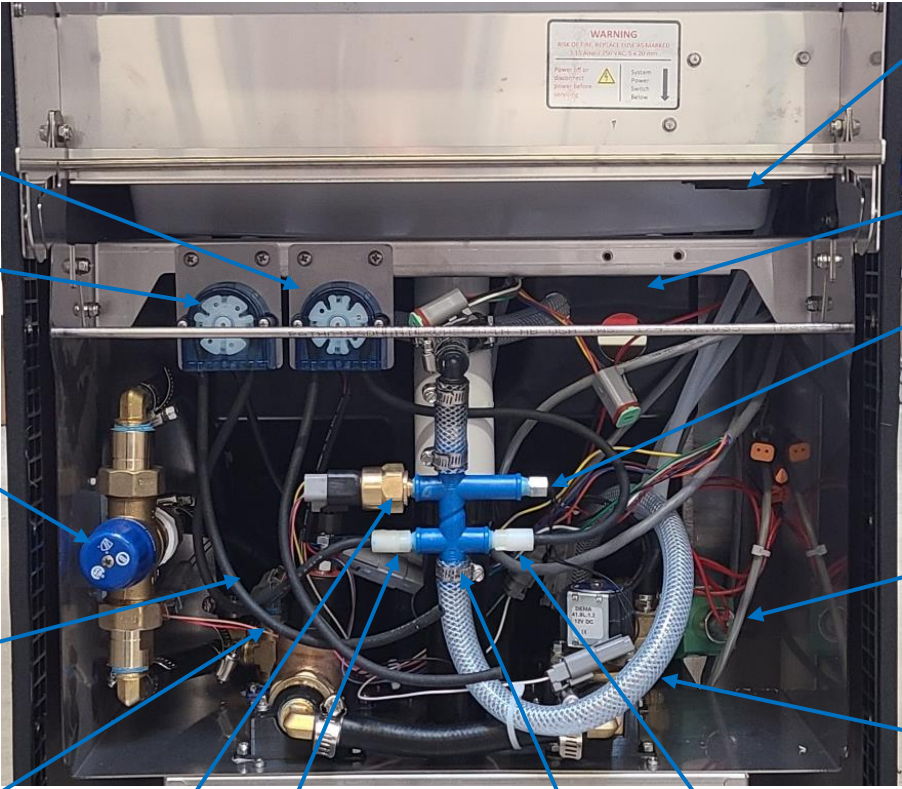

SelfCleanX Solution Pump

UPX Solution Pump

TMV (thermostatic mixing valve)  
ASSE 1070

Facility Hot & Cold-Water  
Inlets w/ Temp Sensors  
(back)

Pressure Regulator &  
Facility Pressure Sensor

Handwash Pressure Sensor

UPX Solution Check Valve

System Power Switch, Fuse  
Holder, IEC Power Cord

Sole Clean or Boot Dip  
Solutions Pump Location  
(if equipped)

Handwash Temp Sensor

Air Curtain Valve  
(if equipped)  
& or Boot Dip  
Valve  
(if equipped)

Water Valve & Backflow  
Preventor – ASSE 1024

SelfCleanX Solution Check Valve

Solution Dosing Chamber

## Internal Components

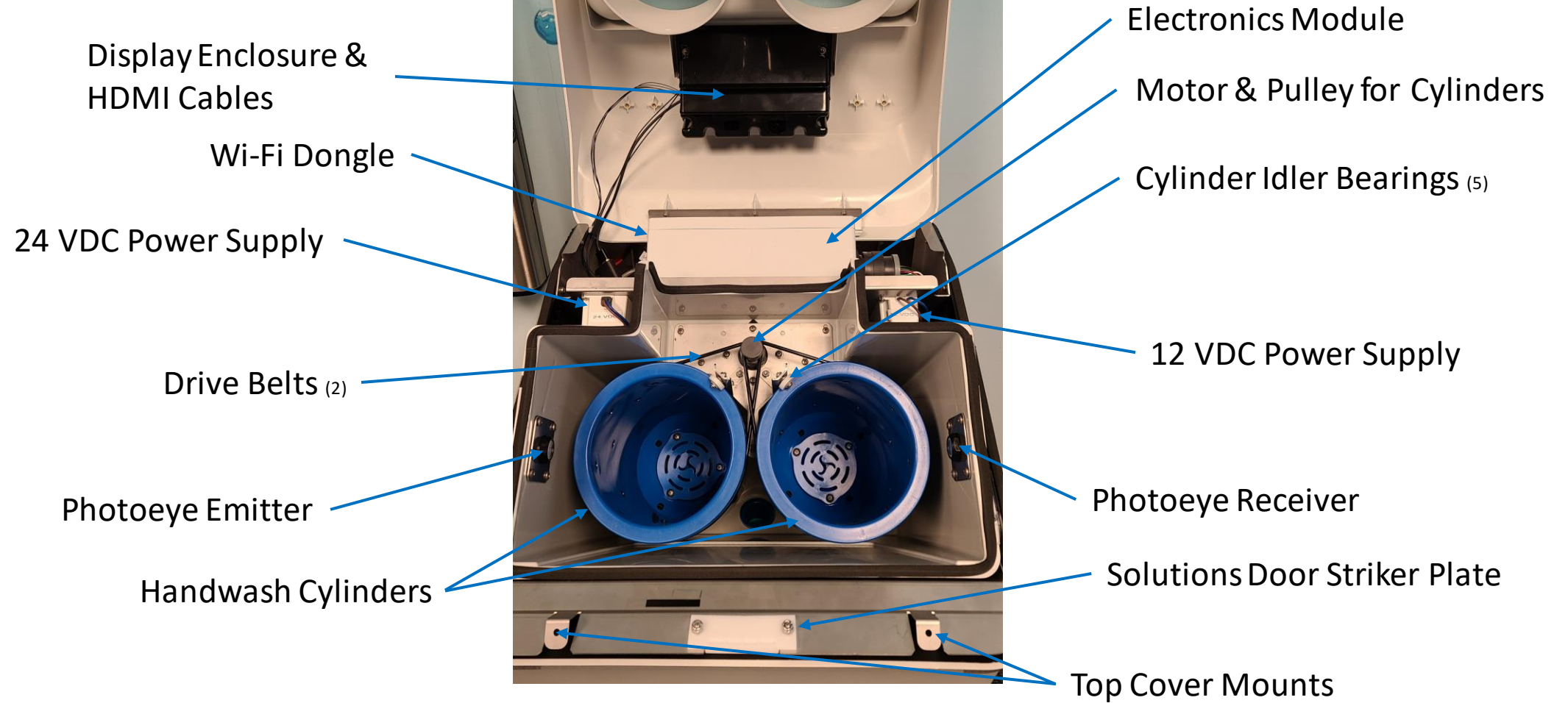

# Internal Components – Air Curtain

Air Curtain Inlet Hose

Air Curtain Inlet Hose

Air Curtain Upper  
Pipe Mounts

Air Curtain Pipes

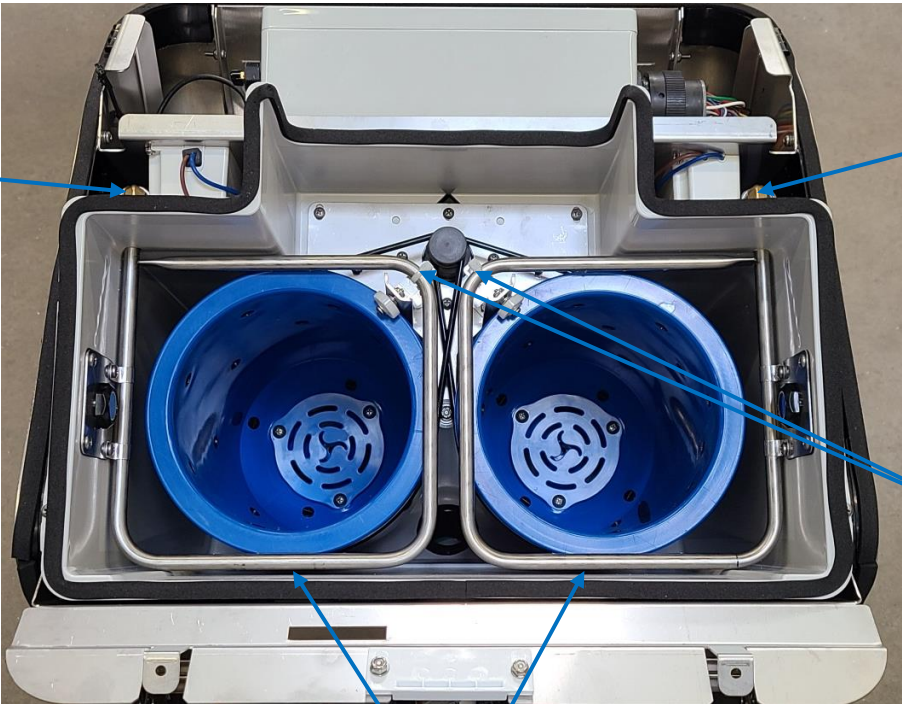

# Components – Sole Clean & Boot Dip

Footwear Hygiene  
Pan (Sole Clean Shown)

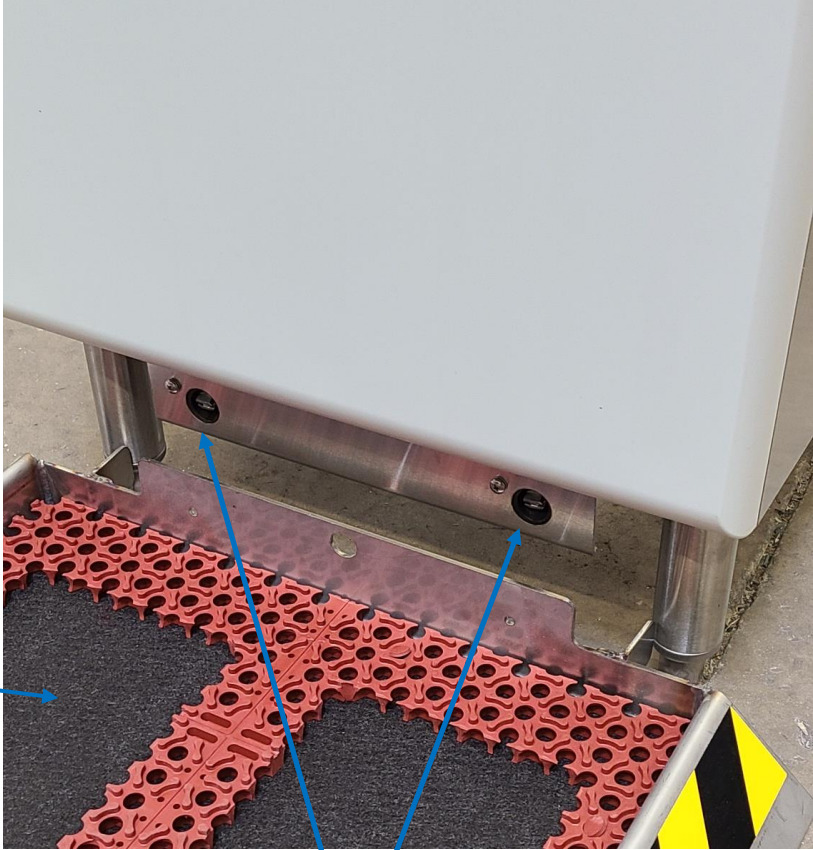

Sole Clean & Boot  
Dip Spray Nozzles  
(Attached to bottom of System)

# Section 5

## Warranty & Terms and Conditions of Sale

### Meritech Limited Warranty

#### WARRANTY COVERAGE

“Meritech” refers to Meritech Systems, LLC d/b/a Meritech, the manufacturer of the accompanying product, consumables and accessories sold new by Meritech or an approved distributor of Meritech (collectively, the “Product”). The “Original Purchaser” refers to the original use purchaser of the Product. Meritech’s warranty obligations are limited to the terms set forth in this Limited Warranty. If you purchased a product from someone other than Meritech or an approved distributor of Meritech, or if the product was used (including but not limited to floor models or refurbished product) prior to your purchase, you are not the Original Purchaser and the product that you purchased is not covered by this Limited Warranty.

Meritech warrants to the Original Purchaser that the Product shall be free from defects in materials and workmanship for a period beginning on the date that Meritech ships the Product to the Original purchaser and ending on the date that is twelve (12) months thereafter (the “Warranty Period”) for parts only. This Limited Warranty does not apply to the following: (a) any third-party products or any third-party operating Stations installed in connection with the Product; (b) any component part from which the serial number has been removed or altered; (c) damage or non-functionality that results from (i) failure to follow the instructions that came with the Product, (ii) usage that is not in accordance with the Product instructions, including without limitation, **use of solutions not supplied by Meritech**, (iii) any act of God, vandalism, fire, lightning, smoke, pollution, particulate matter, wind, snow, icing, power surge, electrical power or water abuse, (iv) problems caused by using accessories, parts, or components not supplied by Meritech, (v) failure to perform preventive or proper maintenance, and (vi) servicing not authorized by Meritech; (d) Boot washer or boot scrubber brushes; and (e) any Product for which Meritech has not received payment from the Original Purchaser.

If a defect exists to the Product, the Original Purchaser’s sole remedy is to make a warranty claim within the Warranty Period, and Meritech’s sole liability shall be to, at Meritech’s election: (a) repair the Component Parts at no charge, using new and refurbished parts; or (b) replace the Product with a product that is new or which has been manufactured from new and serviceable used parts and is at least functionally equivalent to the original Product. A replacement part/product assumes the remaining Warranty Period of the original Product or thirty (30) days from the date of replacement or repair, whichever provides longer coverage to the Original Purchaser. When a product or part is exchanged, any replacement item becomes the Original Purchaser’s property and the replaced item becomes Meritech’s property. Any suspected defect shall be subject to inspection and confirmation by Meritech.

To the extent assignable, Meritech assigns to the Original Purchaser all transferable warranties (and remedies extended thereunder) that have been extended to Meritech by the manufacturers of any of the component parts and, after expiration of the Warranty Period, the Original Purchaser agrees to look solely to such manufacturers with regard to any warranty claims and remedies relating to the Product.

#### WARRANTY DISCLAIMER

MERITECH’S RESPONSIBILITY FOR DEFECTS IN THE PRODUCT IS LIMITED TO REPAIR OR REPLACEMENT, AT MERITECH’S ELECTION, AS SET FORTH IN THIS LIMITED WARRANTY. EXCEPT AS EXPRESSLY SET FORTH IN THIS LIMITED WARRANTY AND SUBJECT TO THE FOREGOING, MERITECH DOES NOT MAKE OR EXTEND, AND THE ORIGINAL PURCHASER ACKNOWLEDGES THAT MERITECH HAS NOT MADE OR EXTENDED, AND MERITECH HEREBY DISCLAIMS FOR ALL PURPOSES, ANY AND ALL OTHER REMEDIES, REPRESENTATIONS, WARRANTIES OR COVENANTS, EXPRESS OR IMPLIED WITH RESPECT TO THE PRODUCT, INCLUDING WITHOUT LIMITATION, ALL WARRANTIES OF MERCHANTABILITY, FITNESS FOR ANY PARTICULAR PURPOSE, PERFORMANCE, CONDITION, DESIGN, APPLICATION, NON-INFRINGEMENT, USE AND/OR DURABILITY. IF MERITECH CANNOT LAWFULLY DISCLAIM IMPLIED WARRANTIES UNDER THIS LIMITED WARRANTY, ALL SUCH WARRANTIES, INCLUDING WARRANTIES OF MERCHANTABILITY AND FITNESS FOR A PARTICULAR PURPOSE ARE LIMITED IN SCOPE TO THE EXTENT POSSIBLE AND IN DURATION TO THE DURATION OF THIS LIMITED WARRANTY. No statement, affirmation or other representation, whether by words or action, of Meritech, its agents, employees or representatives that are not explicitly provided in this Limited Warranty shall constitute a warranty.

#### LIMITATION OF LIABILITY

Notwithstanding anything herein or otherwise to the contrary, express or implied, Meritech’s liability for any claim or action of any kind arising out of, in connection with or resulting from the manufacture, sale, delivery, resale, use or repair of the Product shall not exceed the total cost of the Product. Meritech shall not be liable for errors, costs, or expenses which may be incurred in its performance of its obligations hereunder which results from Meritech’s reliance upon information furnished by the Original Purchaser. MERITECH SHALL NOT BE LIABLE TO ORIGINAL PURCHASER UNDER ANY CIRCUMSTANCES FOR ANY SPECIAL, CONSEQUENTIAL, INCIDENTAL OR PUNITIVE DAMAGES ARISING OUT OF OR IN ANY WAY CONNECTED WITH THIS LIMITED WARRANTY OR THE PRODUCT, INCLUDING BUT NOT LIMITED TO DAMAGES FOR LOST PROFITS, LOSS OF USE, OR FOR ANY DAMAGES OR SUMS PAID BY THE ORIGINAL PURCHASER TO THIRD PARTIES EVEN IF MERITECH HAS BEEN ADVISED OF THE POSSIBILITY OF SUCH DAMAGES. THE FOREGOING LIMITATION OF LIABILITY SHALL APPLY WHETHER ANY CLAIM IS BASED UPON PRINCIPLES OF CONTRACT, WARRANTY, NEGLIGENCE OR OTHER TORT, BREACH OF ANY STATUTORY DUTY, PRINCIPLES OF INDEMNITY OR CONTRIBUTION.

Some states do not allow the exclusion or limitation of incidental or consequential damages, so the above limitations or exclusions may not apply.

#### WARRANTY SERVICE AND OTHER TERMS

Meritech reserves the right to make changes or improvements to Meritech’s products, consumables or accessories from time to time without incurring the obligation to install or implement such improvements or changes on products, consumables or accessories previously manufactured.

Meritech shall be under no obligation to sell replacement parts for, or provide maintenance or other services on, any products, consumables or accessories with respect to which this Limited Warranty does not apply, has expired or has otherwise been voided.

This Limited Warranty gives the Original Purchaser specific legal rights and you may also have other rights which may vary from state to state.

To obtain warranty service under this Limited Warranty during the Warranty Period, please contact our service department at 1-800-932-7707 or [service@meritech.com](mailto:service@meritech.com), or visit our website at [www.Meritech.com](http://www.Meritech.com).

# Standard Terms and Conditions of Sale For Customers

**SCOPE:** These Terms and Conditions apply to all sales made by Meritech Systems, LLC (“Meritech”), and its Meritech Division. These Terms and Conditions apply in lieu of any course of dealing between the parties or usage of trade in the industry.

**TERMS:** Buyer agrees to pay for the products, including all component parts, specified on this invoice (the “Product”) in accordance with the payment terms specified on this invoice. In the event Buyer fails to make any payment to Meritech when due, Buyer’s entire account(s) with Meritech shall become immediately due and payable without notice or demand. All past due amounts shall bear interest from the due date until paid at a rate of 18% per annum. If Buyer fails to pay any amounts outstanding within 10 days of such due date, Meritech may elect to enter Buyer’s principal place of business and any other location where the Product is located and remove the Product. The costs of such removal shall be borne solely by Buyer, and Buyer shall indemnify Meritech and hold Meritech harmless from any damages or other liabilities arising from such removal. The foregoing remedies are in addition to, and not a substitute for, any other remedies provided for herein or that may otherwise be available to Meritech.

**SHIPMENTS:** All products are shipped F.O.B., point of shipment unless otherwise agreed to in writing by Meritech. Risk of loss shall transfer to the Buyer upon tender of goods to Buyer, Buyer’s representative, or common carrier. The cost of any special packing or special handling caused by Buyer’s requirements or requests shall be added to the amount of the order. If Buyer causes or requests a shipment delay, or if Meritech ships or delivers the products erroneously as a result of inaccurate, incomplete or misleading information supplied by Buyer or its agents or employees, storage and all other additional costs and risks shall be borne solely by Buyer. Claims for products damaged or lost in transit should be made by Buyer to the carrier, as Meritech’s responsibility ceases upon tender of goods to Buyer, Buyer’s representative or common carrier.

**INSPECTION AND ACCEPTANCE:** Claims for damage, shortage or errors in shipping must be reported within three days following delivery to Buyer. Buyer shall have 7 days from the date Buyer receives the Product to inspect the Product for defects and nonconformance that are not due to damage, shortage or errors in shipping and notify Meritech, in writing, of any defects, nonconformance or rejection of the Product. After such 7-day period, Buyer shall be deemed to have irrevocably accepted the Product and these Terms and Conditions. After such acceptance, Buyer shall have no right to reject the Product for any reason or to revoke acceptance, or to dispute any of these Terms and Conditions. Buyer hereby agrees that such 7-day period is a reasonable amount of time for such inspection and revocation of the Product. Buyer shall have no right to order any change or modification to the Product or service previously ordered by Buyer or its representatives. Specially fabricated or ordered items may not be returned, and no refund will be made. The sole and exclusive remedy for any alleged defect in workmanship or material will be the replacement of the Product subject to Meritech’s inspection and limited warranty.

**TAXES:** Buyer shall be liable for the payment of all transaction based taxes including without limitation sales, use, gross receipts, compensating, occupation, privilege, excise or other similar taxes assessed in connection with the purchase and sale of the Product by payment of such taxes to Meritech, or by executing and delivering to Meritech a tax exemption certificate or in those jurisdictions where Meritech is not required to administer the laws and regulations of such jurisdiction, a tax indemnification agreement. Any such tax exemption certificate or tax indemnification agreement shall be in form and substance acceptable to Meritech, in Meritech’s sole discretion. Meritech shall have no obligation to pay any taxes, which are Buyer’s sole responsibility.

**SECURITY INTEREST:** Buyer hereby grants Meritech, to secure the payment and performance in full of the purchase price for the Product, plus any fees owed hereunder, a continuing security interest in, and pledges to Meritech, the Product (the “Collateral”), wherever located, whether now owned or hereafter acquired or arising, and all proceeds thereof. Buyer represents, warrants, and covenants that the security interest granted herein is, and shall continue to be, a first priority perfected security interest in the Collateral so long as any portion of the purchase price and fees remains unpaid. Meritech’s security interest in the Collateral shall continue until the purchase price and fees have been paid in full. Upon such payment in full, Meritech shall release its security interest in the Collateral and all rights therein shall revert to Buyer. Buyer hereby authorizes Meritech to file financing statements, without notice to Buyer, in all appropriate jurisdictions that, in Meritech’s sole judgment, are reasonably necessary to perfect or protect Meritech’s interest or rights hereunder.

**TITLE:** Title to the Product shall remain with Meritech until Buyer has paid the entire purchase price and any fees owed hereunder.

**LIMITED WARRANTY:** Meritech makes no warranties with respect to the Product other than those expressly provided in Meritech’s Limited Warranty available on its website at [www.meritech.com](http://www.meritech.com).

**INDEMNIFICATION:** Buyer agrees to protect, indemnify, hold harmless and defend Meritech and its members, managers, officers, affiliates, agents and employees against any and all losses, damages, claims, lawsuits, demands, causes of action, judgments, liabilities and expenses (including attorneys’ fees and related costs) for injury to or death of any persons (including without limitation Buyer, Buyer’s customers, Buyer’s employees and agents, or any employee or agent of them, Buyer’s co-venturers, contractors, subcontractors and suppliers) or damage to or loss of any property or the environment, or violation of any applicable laws or regulations arising in any manner, directly or indirectly, out of or in connection with, or in the course of or incidental to any of Buyer’s use, application or operation of the Product, regardless of cause or of any fault or negligence of Meritech or Meritech’s agents.

**FORCE MAJEURE:** The obligations of Buyer and Meritech shall be suspended and neither shall be liable for any damages suffered by the other if the failure of Buyer or Meritech to perform arises from an event of Force Majeure. An “event of Force Majeure” includes acts of God, weather or other action of the elements, warlike action, insurrection, revolution, civil strife, piracy, civil war, hostile action, strikes or other labor stoppages, acts of public enemies or material changes to state, federal or local laws, rules or regulations. Lack of funds or financial resources shall not be considered an event of Force Majeure.

**REPRESENTATIONS AND WARRANTIES OF BUYER:** Buyer represents and warrants to Meritech that (a) the information set forth on this invoice accurately represents (i) Buyer’s exact legal name; (ii) Buyer’s form of organization and jurisdiction of organization; (iii) Buyer’s principal place of business or executive offices and, if different, mailing address; and (iv) all other information set forth in this invoice pertaining to Buyer is accurate and complete, and (b) Buyer has sufficient financial resources to pay its debts and other financial obligations (including trade debts) as they come due, including the obligation to pay the purchase price and any fees owed hereunder to Buyer.

**COVENANTS:** So long as any portion of the purchase price or fees payable to Meritech hereunder remain unpaid, (a) Buyer shall not, without at least 30 days prior written notice to Meritech: (i) change its jurisdiction of organization, (ii) change its organizational structure or type, (iii) change its legal name, or (iv) change its tax identification number or other organizational number (if any) assigned by its jurisdiction of organization, (b) Buyer shall maintain the Product and keep the Product in good repair and working condition, and (c) Buyer shall not convey, sell, lease, transfer or otherwise remove the Product from Buyer’s facilities, without the prior written consent of Meritech.

**DEFAULT:** Meritech may enter Buyer’s principal place of Business upon prior written notice, and any amounts outstanding as of the date thereof, including without limitation, accrued interest, shall become immediately due and payable if Buyer (a) breaches any covenant, obligation, or warranty specified herein, (b) fails to make any payment due hereunder or pay any other obligations after such obligations are due and Meritech has provided Buyer with notice of such default, (c) becomes insolvent, enters into bankruptcy or a receiver is appointed in respect of any of its business or Buyer makes an assignment for the benefit of creditors, or (d) breaches any other provision of these Terms and Conditions.

**ENFORCEMENT:** The exclusive forum for adjudication of any controversy or dispute relating to the interpretation of or performance under or any matter relating to these Terms and Conditions or the Product shall be the state or federal courts located in the City and County of Denver, Colorado. Buyer waives any objection which it may now or hereafter have to such venue of any such action, suit or proceeding or any claim of forum non conveniens, and irrevocably submits itself to the nonexclusive jurisdiction of any such state or federal court for the purposes of any such action, suit or service proceeding.

**WAIVER:** Any waiver by Meritech of these Terms and Conditions or any defaults hereunder shall not constitute a waiver of the remaining Terms and Conditions or of any partial invalidity or unenforceability, and no failure or delay in exercising any right hereunder shall operate as a waiver thereof.

**SEVERABILITY:** If any provision hereof is held to be illegal, invalid or unenforceable under any present or future laws, such provision shall be fully severable and the terms and conditions herein shall be construed and enforced as if such illegal, invalid or unenforceable provision had never been made a part hereof. The remaining provisions herein shall remain in full force and effect and shall not be affected by such illegal, invalid or unenforceable provisions or by their severance here from.

**GOVERNING LAW:** This transaction shall be governed in all respects by the laws of the State of Colorado, without regard to its conflict of laws provisions. THE U.N. CONVENTION OF CONTRACTS FOR THE INTERNATIONAL SALES OF GOODS SHALL NOT GOVERN NOR APPLY TO ANY MATTERS ADDRESSED HEREIN OR RELATED HERETO.

**SUCCESSORS AND ASSIGNS:** These Terms and Conditions and everything herein contained shall inure to the benefit of and be binding upon Buyer, Meritech and each of their heirs, executors, administrators and permitted successors and assigns.

**ENTIRE AGREEMENT:** This document constitutes the entire, complete, and exclusive agreement between Buyer and Meritech with respect to the subject matter hereof. All prior proposals, negotiations and representations, if any, including any purchase orders or written quotes, that are different from or in addition to the terms and conditions herein are hereby rejected and shall not be binding on Meritech.